

Jim - please file w/manual

OPERATION AND MAINTENANCE MANUAL

VS SERIES

" INLINE "
FUME SCRUBBER

△
△
△
inline
△
△
△

MANUFACTURED BY TFI INTERNATIONAL
5658 E. 58TH
COMMERCE CITY, COLORADO 80022

* A PRODUCT OF TFI / INLINE DESIGN

"VS" series *Inline* Scrubber

Table of Contents

Introduction

- I. Parts List
- II. Installation Instructions
- III. Maintenance
- IV. Trouble Shooting Guide
- V. Specifications & Performance
- VI. Warranty & Terms

Introduction

Thank you for choosing the Inline "VS" series Vertical Wet Scrubber. You have purchased the most reliable, efficient and technically advanced scrubber on the market today. Inline has been tested by an independent laboratory and test results are based on actual removal rates, not formulas or theory of removal as in other scrubber literature that you might read. Each test is performed as close to actual conditions as possible with results based on volumetric measuring and analysis. With these test results, we feel confident that our product will provide "you" the customer, the maximum protection while effectively reducing your emissions with minimal investment.

This unit is designed to be installed at an individual hood or tank. This eliminates the need for an expensive and usually large scrubbing unit typically located above the false ceiling or on the roof and also reduces hazardous chemical buildup within the ducting system. When installed in accordance to the specifications listed in this manual, your scrubber will perform virtually maintenance free for many years.

Rest assured, that the decision you have made is a positive step towards reducing air pollution, not only in your community, but world wide.

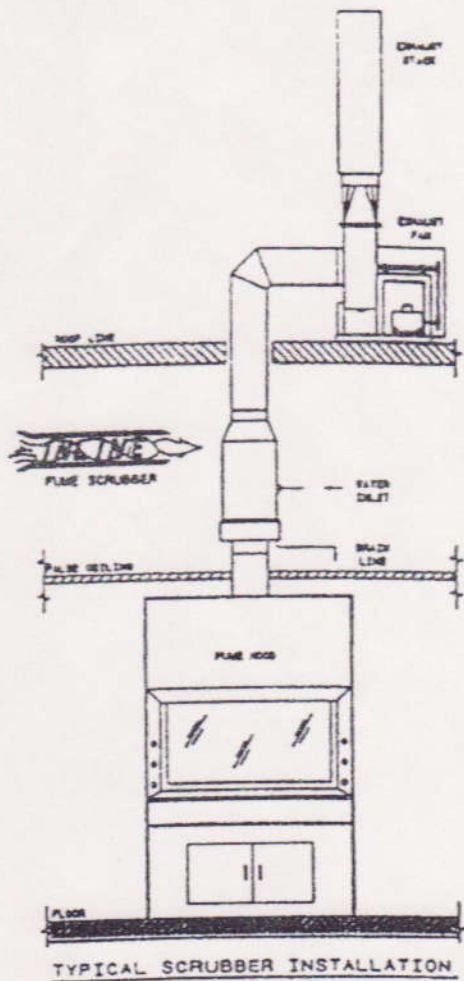

FIGURE 1.0

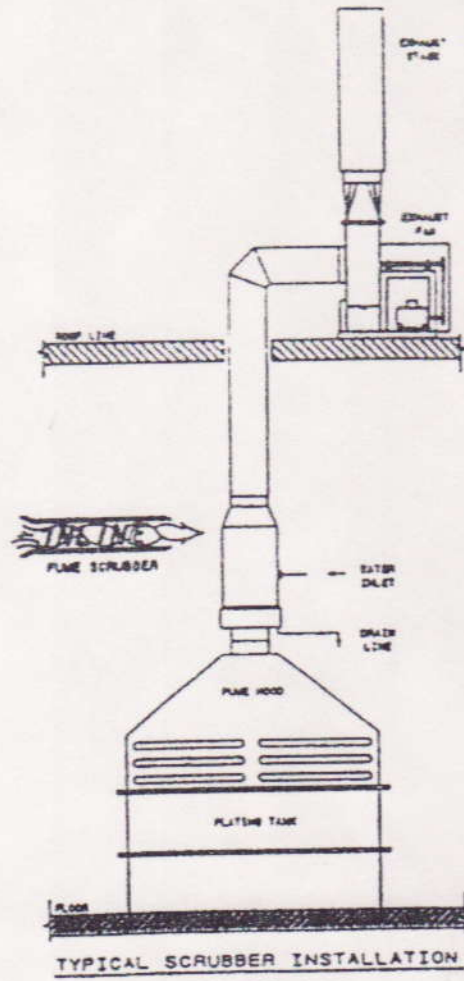

FIGURE 1.1

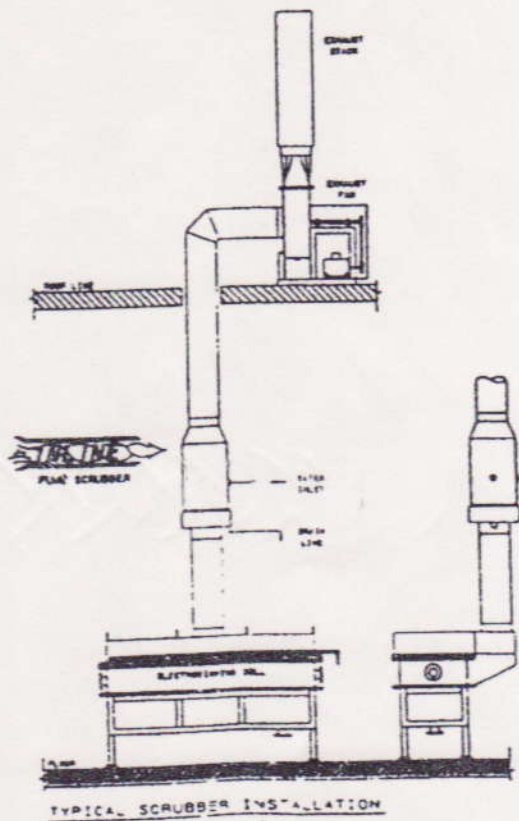

FIGURE 1.2

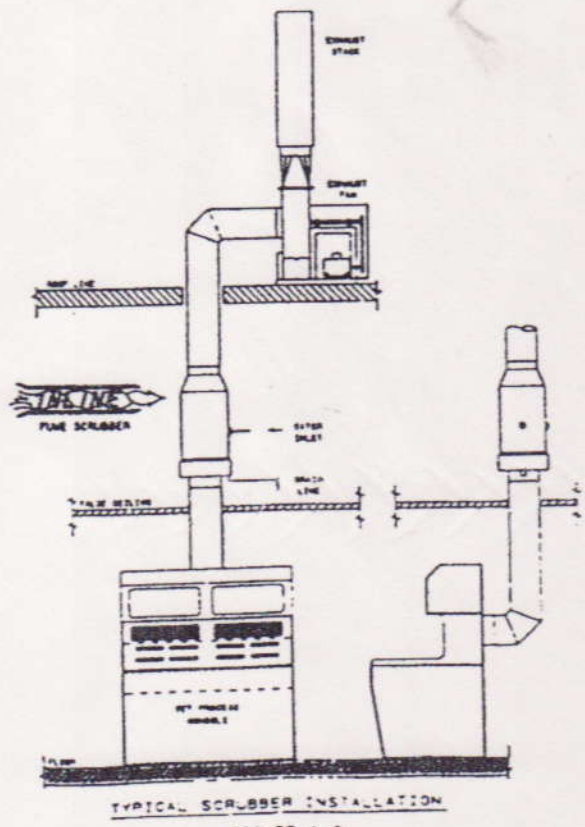

FIGURE 1.3

CHAPTER I
SPARE PARTS LIST

EFFECTIVE 4-26-02

PART NUMBERS

VS-8 VS-10 VS-12 VS-15

A	VS SCRUBBER BODY	VS-08-02-PVC	VS-10-02-PVC	VS-12-02-PVC	VS-15-02-PVC
B	PVC SPRAY NOZZLE ASSEMBLY	SNA-02-PVC	SNA-02-PVC	SNA-02-PVC	SNA-02-PVC-G
C	O-RING FOR 1" UNION	0-457-010	0-457-010	0-457-010	0-457-010
D	1/4" PVC SPRAY NOZZLE (8 GPH)	8GPH-1/4-PVC	8GPH-1/4-PVC	8GPH-1/4-PVC	8GPH-1/4-PVC
E	1" PVC P-TRAP DRAIN ASSEMBLY	PTD-02-PVC	PTD-02-PVC	PTD-02-PVC	PTD-02-PVC-G
F	O-RING FOR 1" UNION	0-457-010	0-457-010	0-457-010	0-457-010
G	STAINLESS STEEL SUPPORT BAND	SB-08-02-SS	SB-10-02-SS	SB-12-02-SS	SB-15-02-SS
	OPERATION & MAINTENANCE MANUAL	VS-0&M	VS-0&M	VS-0&M	VS-0&M

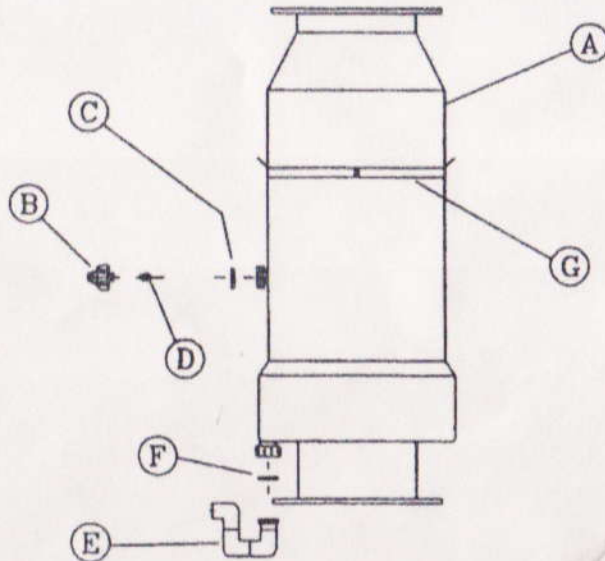

Note : Carefully check shipping carton to make sure that all items listed above are accounted for. If any damage from shipment is noticed, contact the shipper immediately for damage claim. Contact INLINE dealer if a replacement part or repair is required.

Chapter II

Installation

Inline scrubbers are designed to be easily installed by anyone with a basic knowledge of ventilation systems and plumbing. To insure trouble free performance, take a few minutes to read through this manual prior to installing your new scrubber. A local HVAC contractor can also be contacted for installation.

Location for Scrubber:

1. The "VS" *Inline* Scrubber must be installed in a vertical and level position. This is critical to the performance of the scrubber. Choose an area as close to the source of fumes to be exhausted for the best results (see specification chart Fig 5.0 for exact dimensions.)
2. A negative air pressure draw through the scrubber is required. This means that the blower fan is to be located on the outlet side of the scrubber (refer to Fig. 1.0 through Fig. 1.3 for typical installations). A positive air pressure to the inlet is "not" recommended. For existing systems, modifications may be necessary on the blower fan to attain the required CFM. In some cases, a larger blower fan may be required. It is very important for scrubber performance that CFM requirements are achieved (See chapter V.). If less than the specified CFM is available, the use of a balancing tee can be utilized to draw air from another source. This will enable the scrubber to operate at optimum performance (see FIG 2.1). For new and existing installations, it is highly recommended to use an *Inline* model exhaust fan. This fan has been specifically designed for use with the VS-Series to achieve maximum scrubber performance.
3. Since water is used for scrubbing, choose a location that will "not" be subject to below freezing conditions. An inside location with temps between 50 to 80 Degrees F is ideal. If outside installation is necessary, take all precautions required to keep water inlet line, scrubber body, and drain line from freezing.
4. Choose a location that will allow access to the water inlet, and drain line, for periodic inspection and maintenance.
5. When installing in a perchloric acid system use "only" a factory modified scrubber, designed for perchloric acid use
6. Although all VS-Series scrubbers have been tested prior to shipment it is always a good precaution to inspect and water test prior to installation, in the event that any damage was caused during shipping and handling

Installation
Chapter II. Cont.

The Drain Line

1. The drain fitting is located at the base of the scrubber below the water inlet. It consists of an all clear outlet pipe (for visual inspection) and a P-Trap complete with union fitting for disassembly. The drain terminates with a 1" FNPT fitting.
2. The pipe or hose attached to the drain should have a 1" minimum inside diameter. Also make sure that there are no restriction in the line that will prevent or impede drainage, as this would effect the performance of the scrubber.
3. Allow enough flexibility in the connections to permit the drain to be disconnected for maintenance.
4. Always support the drain line independently from the scrubber. This will help prevent damage to the drain fitting.
5. The drain can be routed to the main drain line, a neutralization tank, in house waste treatment system, or other.

Installation
Chapter 11 cont

- A. Visually inspect for any noticeable cracks or damage.
- B. Water test the scrubber. This is done by placing the scrubber in a vertical position on a flat surface. Plug off the drain with 1 inch MPT plug (provided). Pour one gallon of water into the top of the scrubber. Let it set for a minimum of 15 minutes. Inspect to ensure that there is no water leakage. Remove plug and drain.

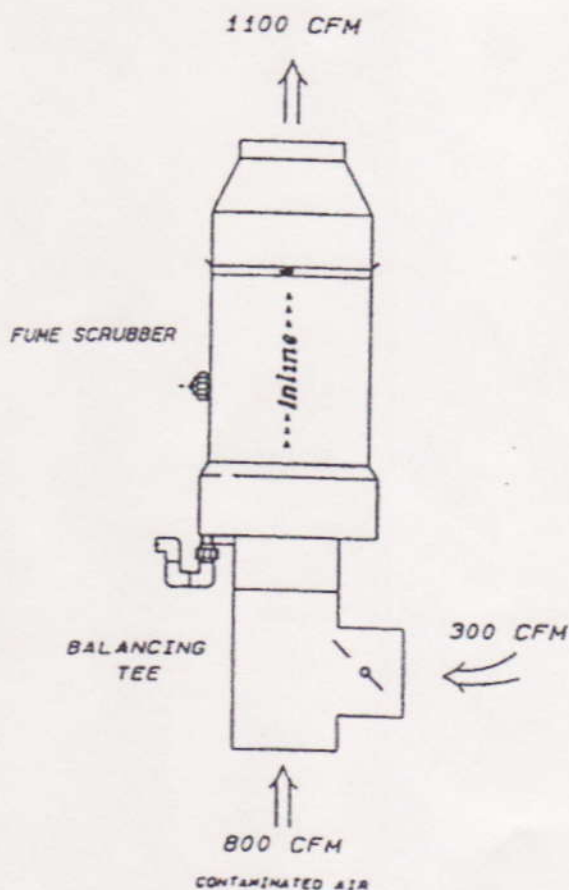

EXAMPLE: VS-12 at 1100 CFM

In this application, only 800 CFM of contaminated air needs to be scrubbed. This is below the requirements of the VS-12 scrubber (min. 980 CFM max. 1185 CFM). A balancing tee can be used to supply the additional 300 CFM needed to make the scrubber operational. The tee can exhaust room air or be ducted to another location.

Fig 2.1

Installation
Chapter II Cont.

Installation of the "VS" Inline Scrubber into a new or existing duct line:

1. The "VS" is equipped with an inlet and outlet flange (see specifications in chapter V), designed to be attached to a mating flange on the hood or duct line. The flanges are blank and can be field drilled to match existing or new bolt patterns.
2. Gasketing and corrosion resistant bolting hardware are recommended. They can be acquired locally or obtained through Inline Design. The following requirements must be met:
 - A. The scrubber must be vertical and level.
 - B. The scrubber should not be required to bear the weight of any duct work or piping attached to it. This should all be supported independently.
 - C. Support the scrubber itself by means of the stainless steel mounting band and/or at the base of the unit. Keep in mind, the operating weight of the scrubber (refer to CHAPTER V.).
 - D. Make sure that inlet and outlet connections are tight fitting and free from leaks and gaps.
3. Note the sizes and materials of connecting duct work or hood opening, and have adapters, offsets or transitions available if necessary.

Inline Scrubber Corp./d.b.a. Inline Design manufactures a complete line of plastic duct fittings, hoods, transitions and blower fans. For further information, contact a sales representative at:

Inline Design
5675 Monaco St.
Commerce City, Colorado 80022
Phone (303)-288-8486 Fax (303)288-6823

Installation
Chapter II. Cont.

Water Inlet Connection

1. The water inlet is located on the side of the scrubber approximately half way up, with a 1/4" FNPT connection. Water requirements are 35-60 PSI line pressure at 8 GPH (gallons per hour) minimum. The spray nozzle it self will regulate the water usage. The standard nozzle is an 8 GPH.
2. A flexible tube connection (such as 1/4" plastic or flexible copper tube) is recommended to hook up. This will allow easy removal of the spray nozzle assembly for maintenance or inspection.
 - A. At installation it is recommended to remove the nozzle and flush the lines prior to operation, to prevent any debris from clogging the nozzle.
 - B. To avoid nozzles clogging, a filter or screen is recommended for inlet water.
3. The water inlet can be controlled by:
 - A. A manual on/off valve.
 - B. An electric solenoid valve (which could be electrically connected to: an on/off switch, the hood, the blower fan, a timer or other).
 - C. A Pump.
4. When installing a scrubber that has been modified for perchloric acid use, "do not" use a common line for water inlet and spray wash down nozzles. Always run an individual line to the water inlet, as it will need to be operative continuously during the scrubber operation.

Chapter III

Maintenance

The "VS" Inline Scrubber has been designed for a minimal amount of maintenance under normal usage. There are no moving parts to wear out, and no packing or mesh filter screens to clean. The only item that may need repair or replacement, is the spray nozzle itself. All other items are designed to last the lifetime of the scrubber.

Inspection of the Spray Nozzle.

1. Turn off the water supply line.
2. To remove the spray nozzle assembly, loosen the 1 ½" union and disconnect it. If flexible tubing is used for connection, the assembly can then be easily removed. Inspect the nozzle for wear or clogging.
3. To test the spray nozzle, hold the assembly over a container and turn on the water supply. Observe the spray pattern to ensure that it emits a full even cone pattern. If not, clean or replace the spray nozzle.
4. To re-assemble, insert the spray assembly back into the union fitting. Make sure the union o-ring is installed. Thread the union nut on (hand tight only is sufficient) and turn on the water supply.
5. For a quick check of the nozzle, this procedure can be done with the scrubber in operation. For nozzle maintenance or repair, scrubber shut down is recommended.
6. Inspection schedule for nozzle will vary depending on chemistry used and/or abrasives of exhaust gasses. A good rule of thumb is to inspect monthly, or if no flow from the drain line is observed.
7. If different flow rates are necessary, only the spray nozzle itself would need to be changed. The spray assembly can be used with a ¼" MNPT full cone nozzle.

Chapter III Cont'd

Maintenance

Inspection of the drain

1. The drain fitting is made of clear PVC material. Periodic visual inspection of liquid flowing through it is all that is required. If drainage is slow, or a build up is present, the drain may need to be cleaned. The scrubber will need to be shut down, and the water supply turned off for this procedure.
2. After the sump has drained, loosen the union nut on the P-Trap drain and disconnect. Flush out and clean the P-Trap drain fitting. Clean and dislodge any debris in the drain fitting. Inspect the drain line for any blockage or back ups, and clean as required.
3. Re-connect the P-Trap drain fitting making sure the union o-ring is in place. Hand tight on the union nut is sufficient.
4. Turn on the water supply. Visually inspect the drain fitting to insure that drainage is unrestricted.
5. The scrubber is then ready for operation.

* If replacement parts are needed, please refer to the part numbers listed in Chapter one.

Chapter IV

TROUBLE SHOOTING

SYMPTOM	POSSIBLE CAUSE	SOLUTION
Water is leaking down inside of duct while scrubber is operating or when shut down	<ul style="list-style-type: none">- Drain outlet or drain line is plugged or restricted.- Scrubber is not level- Drain line is too small.	<ul style="list-style-type: none">- Locate source of the restriction And clean out (see drain inspection in chapter III)- Check scrubber to insure that it is in a vertical and level position.- A 1" minimum drain line is required for proper drainage.
<ul style="list-style-type: none">- The exhaust system is not drawing air properly after installing the scrubber in duct line.	<ul style="list-style-type: none">- The exhaust fan may not be strong enough to overcome the additional S.P. drop across the scrubber.- If installed in a duct system with multiple take offs, the system could be out of balance.	<ul style="list-style-type: none">- Change the pulley sizes on the existing fan to increase air flow.- Increase motor size on fan.- Replace exhaust fan with one of adequate size and impeller configuration (see chapter V for specifications and performance requirements.)- Qualified personnel with experience in exhaust ventilation may be required to rebalance the system.
<ul style="list-style-type: none">- The scrubber is not scrubbing fumes.	<ul style="list-style-type: none">- The spray nozzle is plugged.- The water supply is not turned on.- The chemicals used are not compatible with scrubber design.- The scrubber is overloaded with too many chemical fumes.- Air velocity through the scrubber is out of the recommended operating range (too low or too high)	<ul style="list-style-type: none">- Clean or replace spray nozzle (see chapter III , inspection of spray nozzle).- Turn on the water supply.- See technical specifications and test report manual.- Reduce the amount of fumes.- Adjust blower or balance the system to achieve the proper air flow (see chapter V for specifications

Chapter IV (cont'd)

TROUBLE SHOOTING

SYMPTOM	POSSIBLE CAUSE	SOLUTION
- The exhaust system gradually or suddenly stops drawing air	- Problem with the exhaust fan - Debris (tissue, paper, etc) is clogging the inlet to the scrubber. - The drain line is clogged	- Inspect and remedy the problem - Turn off system and clean out Debris - Locate the source of restriction and clean out.
- Water is being pulled from the scrubber up through the exhaust system, and out past the blower fan (this could also cause sump overflow at shut down, due to excessive water retention).	- The blower speed is too fast - The inlet port is choked off and not allowing proper air flow - The drain line is restricted.	- Slow down the blower by changing pulleys. - Install an adjustable damper above the scrubber outlet to reduce air flow. - Install a balancing tee. - Locate the source of the restriction and remedy.
- Water is leaking from fitting connections.	- Faulty connections. - Union o-ring is missing or not seated properly.	- Disassemble, clean and reassemble. - Inspect and/or replace.
- Water is leaking from the scrubber body.	- The scrubber may have been Cracked or damaged during shipment or installation.	- Return to manufacture for repair (see terms & conditions for return procedures)

Chapter V

Specifications & Performance

SPECIFICATIONS

" INLINE " FUME SCRUBBER

	VS-8	VS-10	VS-12	VS-15
EMPTY WT.	18 LBS.	30 LBS.	45 LBS.	62 LBS.
OPERATING WT.	27 LBS.	46 LBS.	64 LBS.	78 LBS.
WATER REQUIREMENT	8 GAL/HR	8 GAL/HR	8 GAL/HR	8 GAL/HR
WATER PRESSURE	MIN 35 PSI	MIN 35 PSI	MIN 35 PSI	MIN 35 PSI
AIR VOLUME MAX.	250 CFM	720 CFM	1185 CFM	1735 CFM
AIR VOLUME MIN.	240 CFM	580 CFM	980 CFM	1590 CFM
STATIC PRESSURE (IN/WG)	3"	3"-3.9"	2.85"-4.5"	2.77"-4.7"
MATERIAL FOR SCRUBBER	PVC	PVC	PVC	PVC
MATERIAL FOR MIST ELIMINATOR	PVC	PVC	PVC	PVC
MATERIAL FOR SPRAY NOZZLE	PVC	PVC	PVC	PVC
MAX. OPERATING TEMPERATURE	120° F.	120° F.	120° F.	120° F.
MIN. OPERATING TEMPERATURE	35° F.	35° F.	35° F.	35° F.

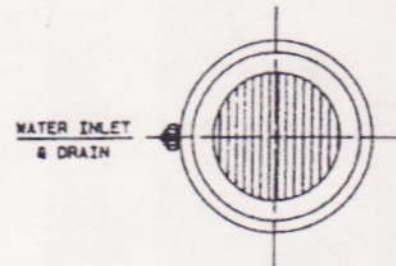

PLAN VIEW

	VS-8	VS-10	VS-12	VS-15
A	38.75"	44.77"	50.75"	61.75"
B	13.60"	17.00"	20.40"	25.50"
C	8.16"	10.20"	12.24"	15.30"
D	8.16"	10.20"	12.24"	15.30"
E	6.50"	6.50"	6.50"	6.50"
F	2"	2"	2"	2.5"
G	5.43"	5.43"	5.43"	5.43"
H	21.083"	24.313"	27.50"	34.375"
J	1/4" FNPT	1/4" FNPT	1/4" FNPT	1/4" FNPT
K	1" FNPT	1" FNPT	1" FNPT	1" FNPT
L	11.75"	13.75"	15.75"	19.75"
M	3/8"	3/8"	3/8"	3/8"

OUTSIDE DIAMETER
OUTSIDE DIAMETER

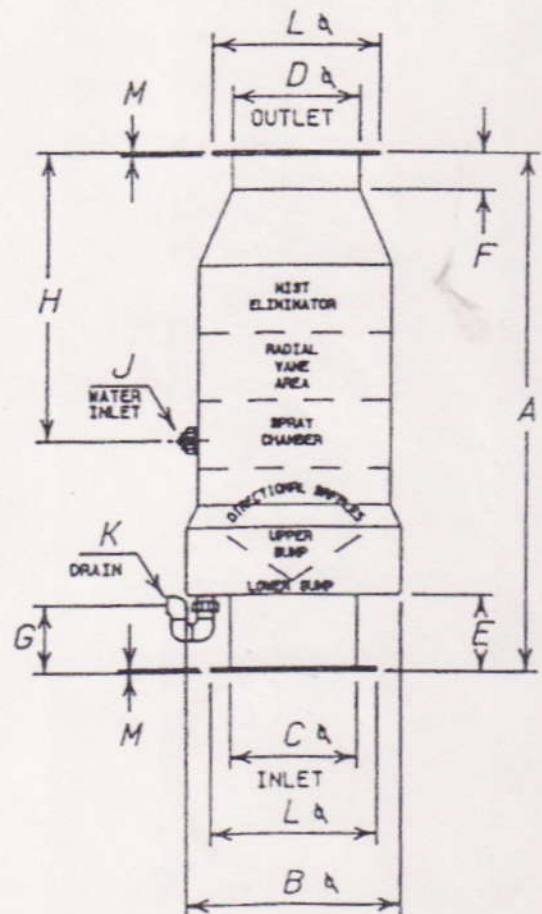

EFFECTIVE 11-18-98

FIG. 5.01

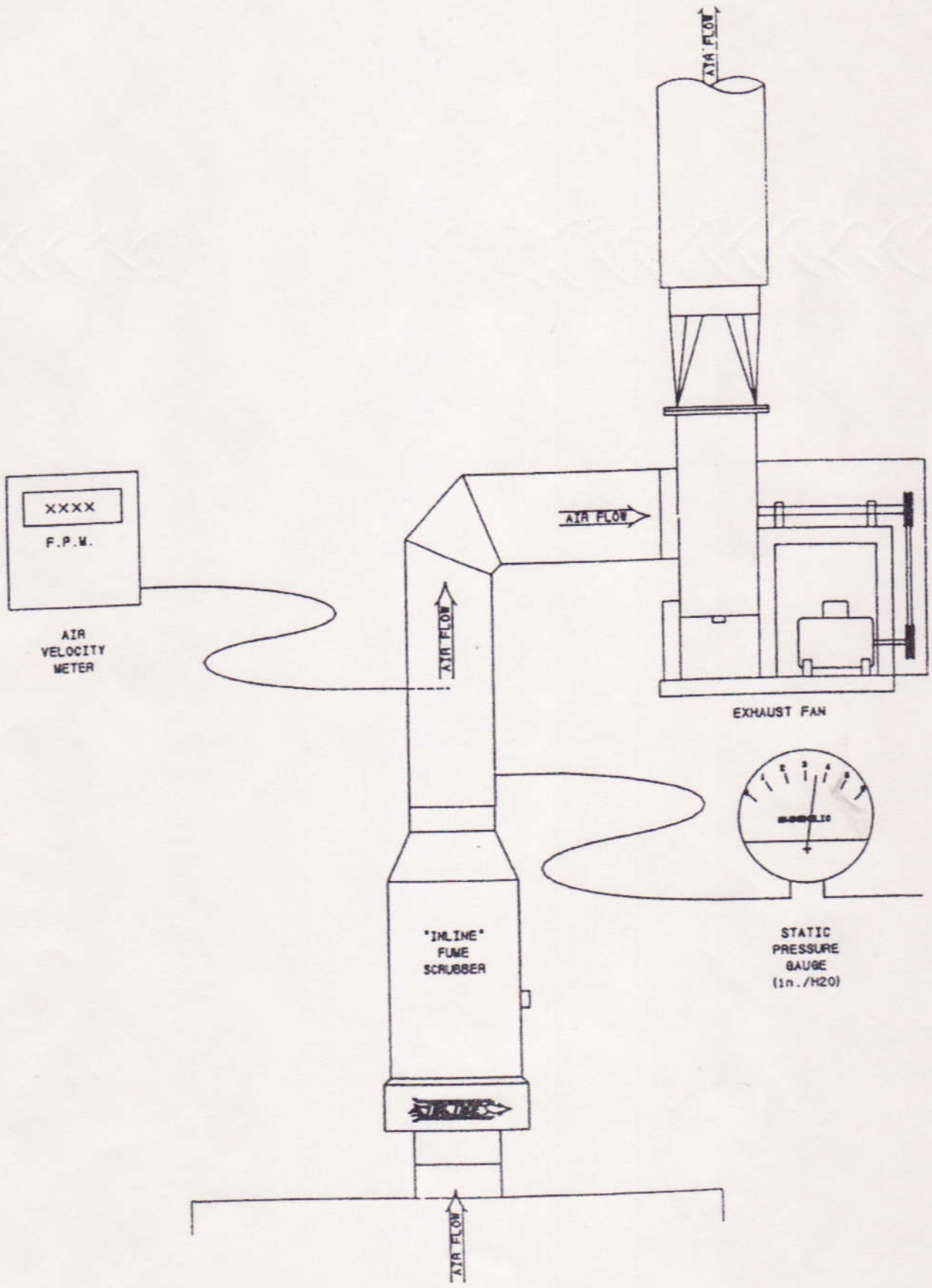

TYPICAL MEASUREMENT LOCATIONS

FIGURE 5.2