

Milli-Q[®] Gradient and Milli-Q[®] Gradient A10[®] User Manual



Notice

The information in this document is subject to change without notice and should not be construed as a commitment by Millipore Corporation. Millipore Corporation assumes no responsibility for any errors that might appear in this document. This manual is believed to be complete and accurate at the time of publication. In no event shall Millipore Corporation be liable for incidental or consequential damages in connection with or arising from the use of this manual.

We manufacture and sell water purification systems designed to produce pure or ultrapure water with specific characteristics ($\mu\text{S}/\text{cm}$, T, TOC, CFU/ml, Eu/ml) when it leaves the water purification system provided that the Elix Systems are fed with water quality within specifications, and properly maintained as required by the supplier.

We do not warrant these systems for any specific applications. It is up to the end user to determine if the quality of the water produced by our systems matches his expectations, fits with norms/legal requirements and to bear responsibility resulting from the usage of the water.

Millipore's Standard Warranty

Millipore Corporation ("Millipore") warrants its products will meet their applicable published specifications when used in accordance with their applicable instructions for a period of one year from shipment of the products. **MILLIPORE MAKES NO OTHER WARRANTY, EXPRESSED OR IMPLIED. THERE IS NO WARRANTY OF MERCHANTABILITY OR FITNESS FOR A PARTICULAR PURPOSE.** The warranty provided herein and the data, specifications and descriptions of Millipore products appearing in Millipore's published catalogues and product literature may not be altered except by express written agreement signed by an officer of Millipore. Representations, oral or written, which are inconsistent with this warranty or such publications are not authorised and if given, should not be relied upon.

In the event of a breach of the foregoing warranty, Millipore's sole obligation shall be to repair or replace, at its option, the applicable product or part thereof, provided the customer notifies Millipore promptly of any such breach. If after exercising reasonable efforts, Millipore is unable to repair or replace the product or part, then Millipore shall refund to the customer all monies paid for such applicable product or part. **MILLIPORE SHALL NOT BE LIABLE FOR CONSEQUENTIAL, INCIDENTAL, SPECIAL OR ANY OTHER INDIRECT DAMAGES RESULTING FROM ECONOMIC LOSS OR PROPERTY DAMAGE SUSTAINED BY ANY CUSTOMER FROM THE USE OF ITS PRODUCTS.**

Copyright

© 2003 MILLIPORE CORPORATION. PRINTED IN FRANCE. ALL RIGHTS RESERVED.
THIS BOOK OR PARTS THEREOF MAY NOT BE REPRODUCED IN ANY FORM WITHOUT THE WRITTEN PERMISSION OF THE PUBLISHERS.

Rev. 3 - 03/06

Trademarks

Millipore is a registered trademark of Millipore Corporation.
Elix, Q-Gard, Millipak and Milli-Q are registered trademarks of Millipore Corporation.
Quantum and RiOs are trademarks of Millipore Corporation.
A10 is a registered trademark of Millipore Corporation.
BioPak is a trademark of Millipore Corporation.
Teflon is a registered trademark of E.I. du Pont de Nemours & Co.
Tygon is a registered trademark of the Norton Company.
ASTM is a registered trademark of the American Society for Testing and Materials.
Allen is a registered trademark of the Holo-Krome Technology Corporation.
Windows and EXCEL are registered trademarks of Microsoft Corporation.
All other trademarks are trademarks of their respective manufacturers.

Milli-Q[®] Gradient and Milli-Q[®] Gradient A10[®]

DECLARATION OF CONFORMITY EUROPEAN UNION EC DIRECTIVES

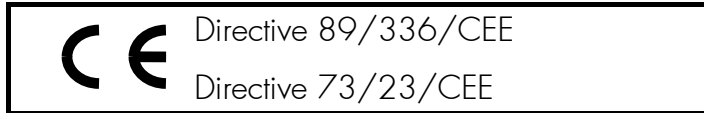

- ◆ The system mentioned above is manufactured in Millipore SAS - 67120 Molsheim - FRANCE - facilities whose quality management system is approved by an accredited registering body to the ISO9001 Quality System Standards.
- ◆ We certify that these Lab Water Systems are designed and manufactured in application of the following European Council directives :
 - 89/336/CEE relating to Electromagnetic compatibility
 - 73/23/CEE relating to electrical equipment designed for use within certain voltage limits
- ◆ Standards to which conformity is declared as applicable are the following :
 - EN 55022 Classe B: 1998: Limits and method of radio-disturbance characteristics of information technology equipment.
 - EN 50082-1: 1997: Electromagnetic compatibility: generic immunity standard.
 - EN 61000-3-2: 1995 / A1 and A2: 1998 / A14: 2000: Electromagnetic compatibility (EMC) Part 3-2: limits : Limits for harmonic current emissions (equipment input current up to and including 16A per phase)
 - EN 61000-3-3: 1995: Electromagnetic compatibility (EMC) Part 3: limits. Section 3: limitation of voltage fluctuation and flicker in low voltage supply systems for equipment with rated current inferior or equal 6A.
 - EN 61010-1: 1993 /A2: 1995: Safety requirements for electrical equipment for measurement, control, and laboratory use.

Guy REYMANN

A handwritten signature in black ink, appearing to read "Guy Reymann", with a long horizontal stroke extending to the right.

Quality Assurance Manager



Directive 2002/96 EC: For European users only

The symbol "crossed bin" on a product or its packaging indicates that the product should not be treated like household waste when discarded. Instead the product should be disposed of at a location that handles discarded electric or electronic equipment.

Proper disposal of equipment containing electric or electronic components will help to reduce pollution effects to the environment or to human health. Proper recycling of these products helps in environmental preservation and helps to protect natural resources. For more information about recycling of products containing electric or electronic components, please contact your local recycling representative or organisation.

TABLE OF CONTENTS

CHAPTER 1	INTRODUCTION	1
1-1	USING THIS MANUAL	1
	<i>Matching this manual with your Milli-Q®</i>	<i>1</i>
	<i>How to use the keypad and the LCD</i>	<i>1</i>
	<i>Commonly used abbreviations in this manual</i>	<i>2</i>
1-2	SAFETY INFORMATION	3
1-3	CONTACTING MILLIPORE	4
	<i>Internet and Email</i>	<i>4</i>
	<i>Manufacturing Site</i>	<i>4</i>
CHAPTER 2	PRODUCT INFORMATION	5
2-1	MILLI-Q PRODUCT WATER SPECIFICATIONS	5
	<i>Water produced by the Milli-Q Gradient or Gradient A10</i>	<i>5</i>
	Flowrate	5
	Resistivity	5
	Particles	5
	Pyrogens	5
	TOC	5
	Micro-Organisms	5
	<i>Comparison of Milli-Q Water and ASTM Standard Specifications</i>	<i>5</i>
2-2	SCHEMATIC OF MAIN COMPONENTS	6
2-3	DESCRIPTION OF MAIN COMPONENTS	7
	<i>Inlet Solenoid Valve</i>	<i>7</i>
	<i>Pressure Relief Valve</i>	<i>7</i>
	<i>Pump</i>	<i>7</i>
	<i>Q-Gard</i>	<i>7</i>
	What are the different types of Q-Gards?	7
	When do I change the Q-Gard Purification Pack?	8
	<i>UV Lamp</i>	<i>8</i>
	When do I change the UV Lamp?	8
	<i>Quantum</i>	<i>8</i>
	What are the different types of Quantum Cartridges?	8
	When do I change the Quantum Ultrapure Cartridge?	8
	<i>Resistivity Sensor</i>	<i>9</i>
	Resistivity and temperature measurements	9
	Temperature Compensation / Conductivity Measurements	9
	<i>Point Of Use Valve</i>	<i>9</i>
	<i>Millipak</i>	<i>9</i>

TABLE OF CONTENTS

What types of Millipak Filters are there?	9
When do I change the Millipak?	9
<i>BioPak</i>	10
What types of BioPak Ultrafiltration Devices are there?	10
When do I change the BioPak?	10
<i>A10 TOC Monitor</i>	10
What does the A10 do?	10
What maintenance is involved with the A10?	10
2-4 TECHNICAL SPECIFICATIONS	12
<i>Dimensions (System and Clearance)</i>	12
<i>Weight</i>	12
<i>Electrical</i>	12
<i>Measurement Ranges for TOC, Resistivity, Conductivity and Temperature</i>	12
<i>Materials of Construction</i>	13
<i>Noise Level</i>	13
CHAPTER 3 PRE INSTALLATION	14
3-1 PRE INSTALLATION CHECKLIST	14
3-2 PRE INSTALLATION CHECKLIST – «ARMLESS» MILLI-Q	15
3-3 OPTIONAL EQUIPMENT YOU MAY NEED	16
<i>Wall Mounting Bracket</i>	16
<i>Pressure Regulator</i>	16
<i>Ball Valve for shutting off the feedwater supply</i>	16
<i>Remote Point Of Use Dispenser</i>	16
<i>Remote Point Of Use Dispenser used on a «Production» type Milli-Q</i>	17
<i>Footswitch</i>	17
<i>Printer or Computer Cable</i>	17
<i>Remote Display with Keypad</i>	17
3-4 INSTALLATION REQUIREMENTS.....	19
<i>Consumables needed for installation</i>	19
<i>Space and Weight Requirements</i>	19
<i>Electrical Requirements</i>	20
<i>Feedwater Requirements</i>	20
<i>Environmental Requirements</i>	20
<i>Other Requirements</i>	20
3-5 UNPACKING THE MILLI-Q BOX – WHAT’S INSIDE?	21
CHAPTER 4 INSTALLATION	23
4-1 CONNECTING TO A SUPPLY OF FEEDWATER	23

TABLE OF CONTENTS

<i>Feedwater is from a reservoir</i>	23
<i>Feedwater is from a pressurised source such as a pipe (a loop)</i>	23
4-2 CONNECTION OF TUBING AND THE POWERCORD.....	25
<i>Feedwater Tubing</i>	25
<i>Feedwater Pressure Relief Tubing</i>	25
<i>Connecting the Powercord</i>	25
4-3 INSTALLATION OF THE Q-GARD.....	27
4-4 TURNING ON THE SYSTEM POWER.....	27
4-5 INSTALLATION OF THE QUANTUM CARTRIDGE.....	27
4-6 INSTALLATION OF THE TYGON TUBING.....	30
4-7 PURGING THE AIR FROM THE SYSTEM.....	30
4-8 HYDRATING THE SYSTEM.....	31
4-9 INSTALLATION AND RINSING OF THE MILLIPAK.....	33
4-10 INSTALLATION AND RINSING OF THE BIOPAK.....	33
4-11 HOW TO CALIBRATE THE FLOWRATE FROM THE MILLI-Q.....	34
4-12 HOW TO CHANGE THE DISPLAYED LANGUAGE.....	36
4-13 HOW TO SHOW EITHER $M\Omega$.CM OR μS /CM (RESISTIVITY OR CONDUCTIVITY UNITS).....	37
4-14 HOW TO SHOW NON TEMPERATURE COMPENSATED RESISTIVITY OR CONDUCTIVITY VALUES.....	39
What is temperature compensation?.....	39
4-15 HOW TO SET THE DATE AND THE TIME OF DAY.....	42
CHAPTER 5 USING THE MILLI-Q.....	44
5-1 HOW TO GET WATER FROM THE MILLI-Q.....	44
5-2 STANDBY, PRE OPERATE AND PRODUCT MODE.....	46
What is STANDBY Mode?.....	46
What is PRE OPERATE Mode?.....	46
What is PRODUCT Mode?.....	46
5-3 HOW TO VIEW THE RESISTIVITY, TEMPERATURE AND TOC.....	47
<i>Viewing Resistivity</i>	47
<i>Viewing Temperature</i>	47
<i>Viewing TOC</i>	47
5-4 HOW TO USE THE FOOTSWITCH (OPTIONAL ACCESSORY).....	48
5-5 HOW TO DISPENSE AN EXACT AMOUNT OF PRODUCT WATER.....	48
5-6 HOW TO VIEW THE AGE OF THE CONSUMABLES.....	50
5-7 HOW TO UNDERSTAND MILLI-Q MESSAGES.....	52
CHAPTER 6 MAINTENANCE.....	55
6-1 MAINTENANCE SCHEDULE.....	55
6-2 HOW TO REPLACE THE Q-GARD.....	56

TABLE OF CONTENTS

6-3	HOW TO REPLACE THE QUANTUM CARTRIDGE	58
6-4	HOW TO REPLACE THE MILLIPAK.....	63
6-5	HOW TO REPLACE THE BIOPAK	63
6-6	HOW TO CLEAN THE SCREEN FILTER	64
6-7	HOW TO TIGHTEN THE POU DISPENSER ARM	66
6-8	HOW TO REPLACE THE A10 UV LAMP	66
6-9	HOW TO CLEAN THE A10 TOC MONITORING DEVICE.....	66
	How long does the A10 Cleaning take?.....	66
	Why would I need to do an A10 Cleaning?	66
	Would an A10 Cleaning ever happen automatically?.....	66
	How do I do an A10 Cleaning?	67
	How do I cancel the A10 CLEANING once it is started?.....	68
6-10	HOW TO REPLACE THE UV LAMP	68
CHAPTER 7	TROUBLESHOOTING.....	69
	<i>The problem is Low or No Flowrate from the POU Dispenser.....</i>	<i>69</i>
	<i>The problem is Low Resistivity of the Product Water</i>	<i>70</i>
	<i>The problem is there is no power to the Milli-Q system.....</i>	<i>70</i>
	<i>The problem is there is an «ERROR Number» Alarm displayed</i>	<i>71</i>
	<i>The problem is a message is displayed with a Flashing Service or Alarm LED.....</i>	<i>73</i>
	<i>Other Troubleshooting items.....</i>	<i>74</i>
CHAPTER 8	ORDERING INFORMATION	75
8-1	CATALOGUE NUMBERS FOR CONSUMABLES	75
8-2	CATALOGUE NUMBERS FOR ACCESSORIES.....	76
8-3	CATALOGUE NUMBERS FOR ALL MILLI-QS	76
CHAPTER 9	APPENDIXES.....	77
APPENDIX 1	HOW TO REPLACE THE MAIN POWER FUSE	77
APPENDIX 2	HOW TO TRANSFER INFORMATION TO A PRINTER	79
APPENDIX 3	HOW TO TRANSFER INFORMATION TO A COMPUTER	81
APPENDIX 4	HOW TO USE A REMOTE DISPLAY	84
APPENDIX 5	HOW TO USE A REMOTE POU DISPENSER	84
APPENDIX 6	COMP MODE 1 AND COMP MODE 2.....	85

Chapter 1 INTRODUCTION

1-1 USING THIS MANUAL

MATCHING THIS MANUAL WITH YOUR MILLI-Q®

This manual is intended for use with a Millipore Milli-Q Gradient or Gradient A10 Water Purification System.

This User Manual is a guide for use during the installation, normal operation and maintenance of a Milli-Q Gradient or Milli-Q Gradient A10 Water Purification System. It is highly recommended to completely read this manual and to fully comprehend its contents before attempting installation, normal operation or maintenance of the Water Purification System.

You can easily identify your type of Water Purification System if you do not see the Catalogue Number. The Milli-Q Gradient and Gradient A10 Water Purification Systems have a Purple Door on the front cabinet.

If this manual is not the correct one for your Water Purification System, then please contact Millipore.

HOW TO USE THE KEYPAD AND THE LCD

The Keypad and LCD (liquid crystal display) are located on the front of the Water System Cabinet.

The Keypad buttons sometimes have a slight delay when pressed. As an example, suppose you want to change the Milli-Q from STANDBY Mode to PRE OPERATE Mode. This is done by pressing the OPERATE/STANDBY Keypad button for about two seconds.

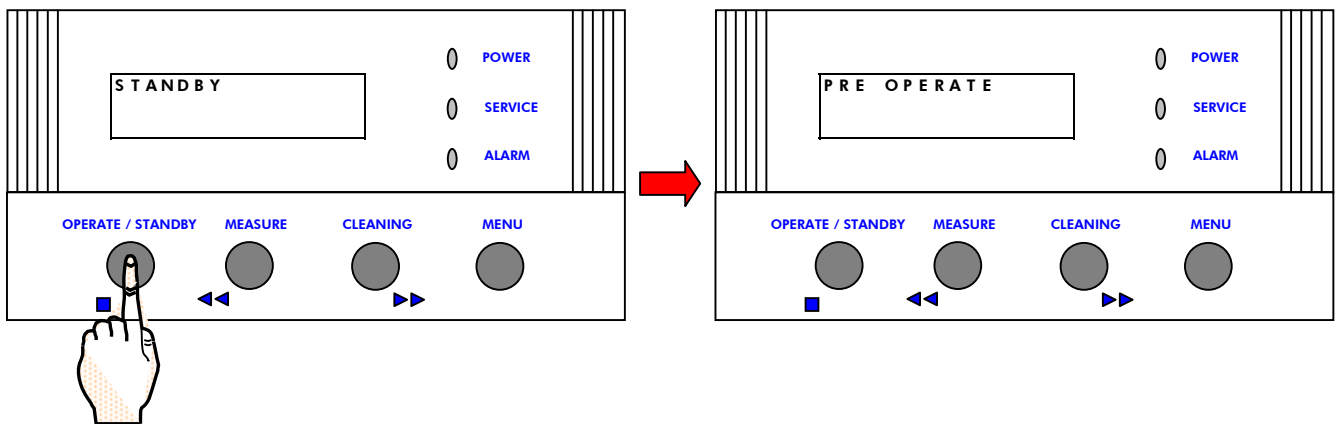

There are four Keypad buttons. These are labelled as OPERATE/STANDBY, MEASURE, CLEANING and MENU. See the drawing above for their placement.

The LCD is a backlit, dual line 16-character display.

The LEDs are located to the right of the LCD (see above). The POWER LED is green. This is lit when the Water System microprocessor has electrical power. The SERVICE LED is yellow. This will flash when a service type of LCD message is displayed (i.e. EXCH. CARTRIDGES. is shown, meaning to change the cartridges in the system). The ALARM LED is red. This will flash when an alarm condition is indicated on the LCD (i.e. PAK NOT IN PLACE, meaning a purification pack is not fully in place or is absent).

COMMONLY USED ABBREVIATIONS IN THIS MANUAL

This manual will use abbreviations for text that is commonly repeated (i.e. Liquid Crystal Display is abbreviated as LCD).

The table below shows a list of the abbreviations used in this manual.

ABBREVIATION	FULL TEXT
µm	micron (unit of length)
µS/cm	microSiemens per centimeter (a measurement unit describing the electrical conductivity of water)
A10®	a Millipore device which measures TOC in Ultrapure Water
ASTM®	American Society for Testing and Materials
CFU/ml	Colony Forming Units per milliLitre
EDI	Electrical Deionisation (referred to as Elix® also)
Eu/ml	Endotoxin Units per milliLitre
LCD	Liquid Crystal Display
LED	Light Emitting Diode
LPM	Litre Per Minute
MΩ.cm	Megohm.centimeter
MΩ.cm @ 25°C	Megohm.centimeter when measured at 25°C
mm	millimeter
NPT	National Pipe Thread (the type of thread used on a fitting)
NPTF	National Pipe Thread Female
NPTM	National Pipe Thread Male
OD	Outer Diameter
ppb	part per billion; a microgram per Litre (µg/L)
RO	Reverse Osmosis
SANIT.	Sanitisation
TOC	Total Organic Carbon
UF	Ultrafilter Cartridge
UV	Ultraviolet

1-2 SAFETY INFORMATION

Your Milli-Q Water Purification System should be operated according to the instructions in this manual. In particular, the hydraulic and electrical specifications should be followed and met. It is important to use this equipment as specified in this manual; using this equipment in a different manner may impair the safety precautions of the Water System.

	THIS HAZARD symbol is used to refer to instructions in this manual that need to be done safely and carefully
---	---

	THIS ATTENTION symbol is used to refer to instructions in this manual that need to be done carefully
---	---

Other safety symbols



Danger



Danger: UV radiation



Electrical Danger



Ground Connection

1-3 CONTACTING MILLIPORE

INTERNET AND EMAIL

The Millipore Internet Site can be used to find addresses, telephone/fax numbers, and other information.

Internet Site Address: www.millipore.com
 www.millipore.com/techservice

MANUFACTURING SITE

Millipore SAS
67120 Molsheim
FRANCE

Chapter 2 PRODUCT INFORMATION

2-1 MILLI-Q PRODUCT WATER SPECIFICATIONS

WATER PRODUCED BY THE MILLI-Q GRADIENT OR GRADIENT A10

FLOWRATE

1.3 - 1.7 LPM with Millipak® Express 20

1.3 – 1.7 LPM with BioPak™

RESISTIVITY

Minimum 18.0 MΩ.cm @ 25°C

Typically 18.2 MΩ.cm @ 25°C

PARTICLES

≤ 1/ml (particle size > 0.22 μm)

PYROGENS

BioPak installed

< 0.001 Eu/ml

TOC

Maximum 5 ppb (this specification came from test conditions where a Milli-Q Gradient was fitted with a Q-Gard® 1 Purification Pack and a Quantum™ EX Ultrapure Cartridge and the feedwater came from a Millipore RiOs™ Water System. The feedwater TOC value was < 50 ppb). The TOC of the Milli-Q Product Water can vary as a function of the feedwater TOC.

MICRO-ORGANISMS

≤ 1 CFU/ml

COMPARISON OF MILLI-Q WATER AND ASTM STANDARD SPECIFICATIONS

Milli-Q Product Water Quality will meet or exceed ASTM Type I Standard Specifications for Reagent Grade Water.

The specifications for ASTM Type I Reagent Grade Water are shown below. **Note that the Water Quality Specifications for a Milli-Q Gradient (or Milli-Q Gradient A10) are listed in the section just above.**

(From «Standard Specification for Reagent Water» Designation: D 1193 – 99; American Society For Testing And Materials)

ASTM Type I Standard Specifications for Reagent Grade Water	
Parameter	Value
Conductivity @ 25°C (μS/cm)	0.056
Resistivity @ 25°C (MΩ.cm)	18
Total Silica max. value (μg/L)	3
Total Organic Carbon max. value (μg/L)	100
Chlorides max. value (μg/L)	1
Sodium max. value (μg/L)	1
pH	not specified (The measurement of pH has been eliminated for this standard because this grade of water does not contain constituents in sufficient quantity to alter pH)

2-2 SCHEMATIC OF MAIN COMPONENTS

The water flow through a **Milli-Q Gradient Water Purification System** is shown here in a flow diagram. A description of each item is in the next section below.

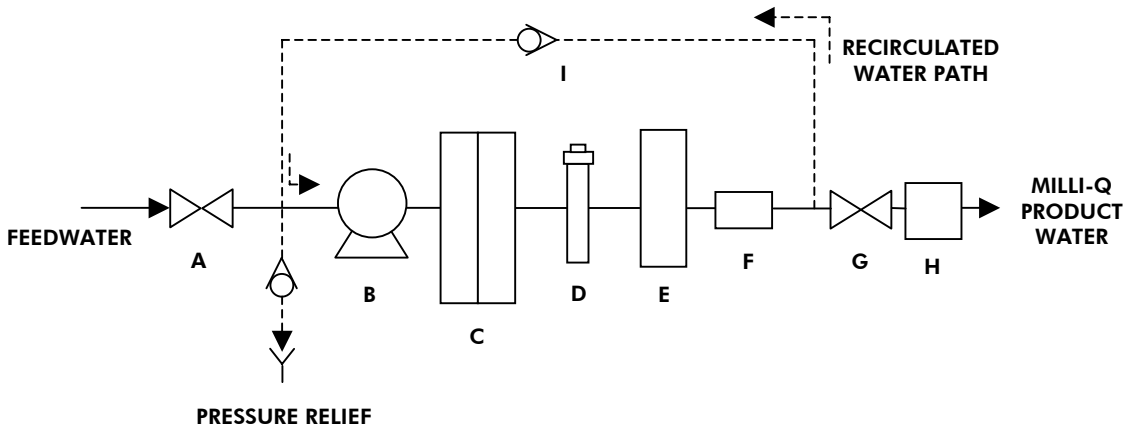

The water flow through a **Milli-Q Gradient A10** is shown here in a flow diagram.

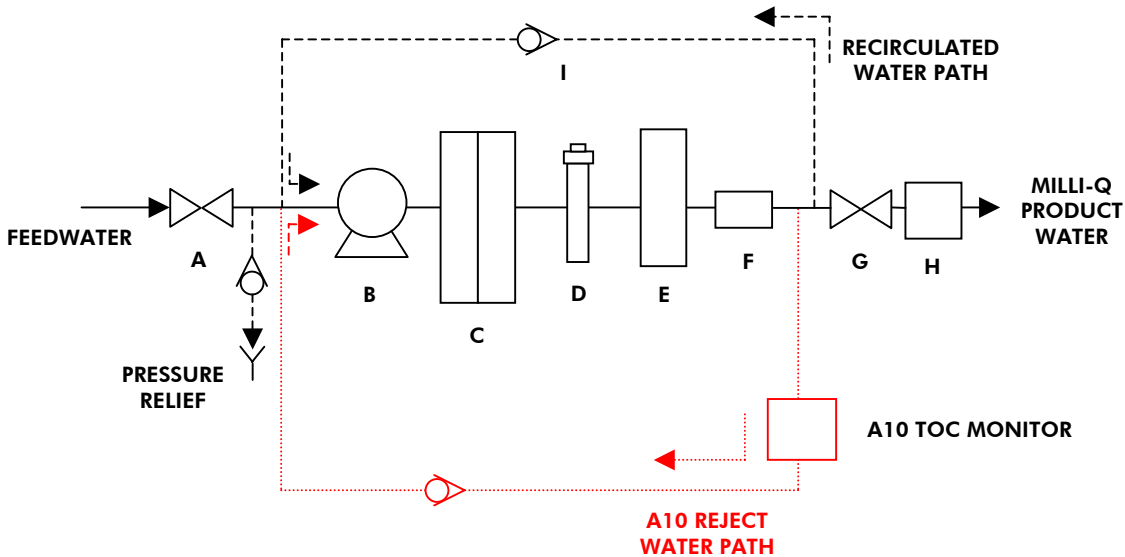

Identification of lettered items in the flow schematic above					
A	Inlet Solenoid Valve	D	UV Lamp and Housing	G	Electric 2-way Valve
B	Pump	E	Quantum Ultrapure Cartridge	H	Millipak Membrane Filter or BioPak
C	Q-Gard Purification Pack	F	Resistivity Sensor	I	Check Valve

2-3 DESCRIPTION OF MAIN COMPONENTS

INLET SOLENOID VALVE

The Inlet Solenoid Valve is used to control the flow of feedwater into the Milli-Q system. The Inlet Solenoid Valve is only open when the system is delivering water from the Point Of Use Dispenser.

PRESSURE RELIEF VALVE

The Milli-Q system has a Feedwater Pressure Relief Valve inside. The purpose of this is to vent out any feedwater that has a pressure higher than 0.75 bar (11 psi). This would prevent any excessive feedwater pressure that could build up in the Milli-Q system during RECIRCULATION Mode.

A piece of tubing is included in the Accessories Bag. This tubing is attached to the Milli-Q system and then placed in a drain or sink. When the incoming feedwater has a pressure greater than 0.75 bar, the Pressure Relief Valve will open up and feedwater will be vented to drain via the attached tubing. The water will stop flowing to drain when the feedwater pressure drops to less than 0.75 bar. If a pressure regulator is installed on the Feedwater Tubing (between the Milli-Q and a Loop), then it is unlikely that the feedwater pressure will get this high.

The installation of this tubing is described in more detail in Chapter 4 (Installation).

A Milli-Q fed from a reservoir will not need the Pressure Relief Valve tubing. A Milli-Q fed from a pressurised pipe (a loop) should have the Pressure Relief Valve tubing installed during installation. Please note that the Pressure Relief Valve is factory installed inside all Milli-Q Systems and only the tubing needs to be attached during installation.

PUMP

The Pump is used to bring water into the Milli-Q and then to send it through the various components such as the Q-Gard Purification Pack and the Quantum Ultrapure Cartridge.

Q-GARD

The Q-Gard Purification Pack is used to remove ions and organic molecules from the feedwater. The Q-Gard is a consumable device. A consumable device is something that is periodically changed out for a new one during the maintenance of the Water System.

WHAT ARE THE DIFFERENT TYPES OF Q-GARDS?

The **Q-Gard 1** is used when the feedwater comes from RO, distillation or Electrodeionisation (EDI). An example of RO or EDI feedwater is the water coming from either a Millipore RiOs or Elix Water Purification System. This type of feedwater typically has some ions but contains little organic, particulate and colloidal contamination.

The Millipore Catalogue Number for a Q-Gard 1 is QGARD00R1. See Section 8-1 for more information.

The **Q-Gard 2** is used whenever the feedwater comes from a source other than those mentioned above. An example of feedwater requiring a Q-Gard 2 would be Service Deionised Water (this is the process of deionising water by connecting bottles of ion exchange directly to tap water and deionising the tap water). Deionised Water produced by multiple regeneration ion exchange resins may have a high level of organic, particulate and colloidal contamination.

The Millipore Catalogue Number for a Q-Gard 2 is QGARD00D2. See Section 8-1 for more information.

WHEN DO I CHANGE THE Q-GARD PURIFICATION PACK?

The decision to change a Q-Gard Pack is either based upon either time (calendar days) or water quality or both.

The **Milli-Q Gradient** will indicate a message «EXCH. CARTRIDGES» after one of 2 events. The first event is that 180 Calendar Days have passed since the last exchange of the Q-Gard (and Quantum – see section below). The second event is when the Product Water resistivity is below a Resistivity Setpoint (set in the software of the Milli-Q). So, if one of these events occurs, it is recommended to replace the Q-Gard Purification Pack.

The **Milli-Q Gradient A10** will display a message «EXCH. CARTRIDGES» only when the Product Water Resistivity is below a Resistivity Setpoint (set in the software of the Milli-Q). The Milli-Q Gradient A10 will not display the message «EXCH. CARTRIDGES» after 180 Days.

UV LAMP

The dual wavelength UV Lamp emits light at 185 nm (for TOC reduction) and 254 nm (Germicidal action). The UV Lamp is used to kill bacteria and to reduce the levels of organic molecules in the water stream between the Q-Gard Pack and the Quantum Cartridge. The UV Lamp has a Millipore Catalogue Number of ZMQUVLP01.

WHEN DO I CHANGE THE UV LAMP?

It is recommended to change the UV Lamp every 365 Days (once per year). The Milli-Q LCD will show a message «EXCHANGE UV» after 365 Calendar Days indicating it is time to replace the UV Lamp.

QUANTUM

The Quantum Ultrapure Cartridge is used to remove trace levels of ions and organic molecules.

WHAT ARE THE DIFFERENT TYPES OF QUANTUM CARTRIDGES?

The **Quantum IX** contains only Mixed Bed Ion Exchange resin. This type of Quantum Cartridge is used when maintaining absolutely trace levels of ions is critical.

The Millipore Catalogue Number for a Quantum IX is QTUM000IX. See Section 8-1 for more information.

The **Quantum EX** contains ion exchange resin and synthetic carbon. These purification media are used when the Milli-Q Product Water needs to have both trace levels of ions and trace levels of organic species.

The Millipore Catalogue Number for a Quantum EX is QTUM000EX. See Section 8-1 for more information.

The **Quantum VX** contains media that removes Volatile Organic Carbon species and maintains trace levels of ions.

The Millipore Catalogue Number for a Quantum VX is QTUM000VX. See Section 8-1 for more information.

WHEN DO I CHANGE THE QUANTUM ULTRAPURE CARTRIDGE?

It is recommended to change the Quantum Ultrapure Cartridge when the Q-Gard Purification Pack is changed. See «When do I change the Q-Gard Purification Pack» (see the section above) for more information.

RESISTIVITY SENSOR

RESISTIVITY AND TEMPERATURE MEASUREMENTS

The resistivity sensor is used to measure the electrical resistivity of the Milli-Q Product Water. Additionally, a thermistor (temperature sensor) is located in the resistivity sensor. The temperature displayed on the Milli-Q LCD during PRODUCT Mode is measured by this thermistor.

TEMPERATURE COMPENSATION / CONDUCTIVITY MEASUREMENTS

The resistivity and temperature are measured while water is flowing through the sensor. The Milli-Q microprocessor will then temperature compensate the resistivity to a 25°C value. It is possible to use the Milli-Q software to display non-temperature compensated resistivity. It is also possible to display conductivity ($\mu\text{S}/\text{cm}$) (temp. compensated or non-temp. compensated) on the LCD by using the Milli-Q software. The software can be changed by using the Keypad.

POINT OF USE VALVE

The Point Of Use (POU) Dispenser has a 2-way electric valve inside.

This valve is closed when the POU Dispenser Trigger is in the upright position. This also places the Milli-Q into PRE OPERATE Mode after 90 seconds if you were using the Milli-Q in PRODUCT Mode.

When the POU Trigger is pushed down, the electric valve is powered. This allows water to be dispensed out of the Milli-Q System instead of being recirculated back to the pump (see flow diagram).

MILLIPAK

The Millipak End Filter is a membrane based filter that removes all particles and bacteria with a size greater than 0.22 μm by a sieving mechanism. All contaminants larger than the filter pore size are retained on its surface. This essentially will block and retain any bacteria present in the water flowing through it.

WHAT TYPES OF MILLIPAK FILTERS ARE THERE?

There are 2 types of Millipak Filters (sometimes called the Final Filter).

The Sterile Millipak 40 is generally used for some Life Science applications. This has a Millipore Catalogue Number of MPGL04SK2. See Section 8-1 for more information.

The Non Sterile Millipak Express 20 is generally used for Analytical Science Applications including applications where trace levels of Volatile Organic Compounds are desired or with Life Science Applications where Endocrine Disrupter Analysis is being done. The Non Sterile Millipak Express 20 has a Millipore Catalogue Number of MPPG02001. See Section 8-1 for more information.

WHEN DO I CHANGE THE MILLIPAK?

The Millipak is changed when the Q-Gard Purification Pack and the Quantum Ultrapure Cartridge are changed. However, it may be necessary to change the Millipak if it becomes clogged with particles or bacteria and reduces the flowrate of Milli-Q Product Water.

BIOPAK

The BioPak is an Ultrafiltration Device that is attached to the end of the POU Dispenser instead of a Millipak. The BioPak will remove both bacteria and Endotoxins (Pyrogens) from the Milli-Q Product Water. The Molecular Weight Cut Off (MWCO) for a BioPak is 13,000.

WHAT TYPES OF BIOPAK ULTRAFILTRATION DEVICES ARE THERE?

There is only one type of BioPak.

The Millipore Catalogue Number for a BioPak is CDUFBI001.

WHEN DO I CHANGE THE BIOPAK?

The BioPak is replaced every 90 Days. The Milli-Q system will not display a message indicating to change the BioPak.

Installation and replacement dates need to be written on a label delivered with the BioPak.

A10 TOC MONITOR

WHAT DOES THE A10 DO?

The A10 TOC Monitor (called A10 in this manual) is used to measure the TOC of the Milli-Q Product Water. The A10 is located inside the Milli-Q System Cabinet. **Any Milli-Q system with an A10 inside will have 'A10' on the end of the name of the Milli-Q (i.e. Milli-Q Gradient A10 vs. Milli-Q Gradient).**

An A10 TOC measurement is initiated every time the Milli-Q is brought from PRE OPERATE to PRODUCT Mode (when the POU Dispenser Trigger is brought forward). A single TOC Measurement will take approximately 5 minutes. It is possible to have a TOC analysis time of either 9 or 12 minutes when the TOC levels are high. The A10 will continuously perform TOC measurements while the Milli-Q is in PRODUCT Mode. The A10 will perform a TOC measurement once per hour while the Milli-Q is in PRE OPERATE Mode. The A10 will not perform any TOC measurements when the Milli-Q is in STANDBY Mode.

WHAT MAINTENANCE IS INVOLVED WITH THE A10?

The A10 uses a small UV light during its TOC Analysis Mode. The A10 UV Lamp needs to be replaced periodically. The normal useful lifetime of the A10 UV Lamp is 1 year. The Milli-Q system uses a calendar day timer to record the age of the A10 UV Lamp. A service message is prompted after 365 Days («EXCHANGE A10 UV») to remind you to change the A10 UV Lamp. **The Catalogue Number for the A10 UV Lamp is ZFA10UV01.**

There is a Cleaning Mode for the A10. This Cleaning Mode can be initiated with the Milli-Q software. The A10 CLEANING Mode does not use a chemical reagent of any kind. The A10 CLEANING Mode is explained in further detail in the Maintenance Section of this manual.

PRODUCT INFORMATION

Q-GARD



QUANTUM



MILLIPAK



2-4 TECHNICAL SPECIFICATIONS

DIMENSIONS (SYSTEM AND CLEARANCE)

The height, width and depth of a Milli-Q Gradient (and Gradient A10) are shown here:

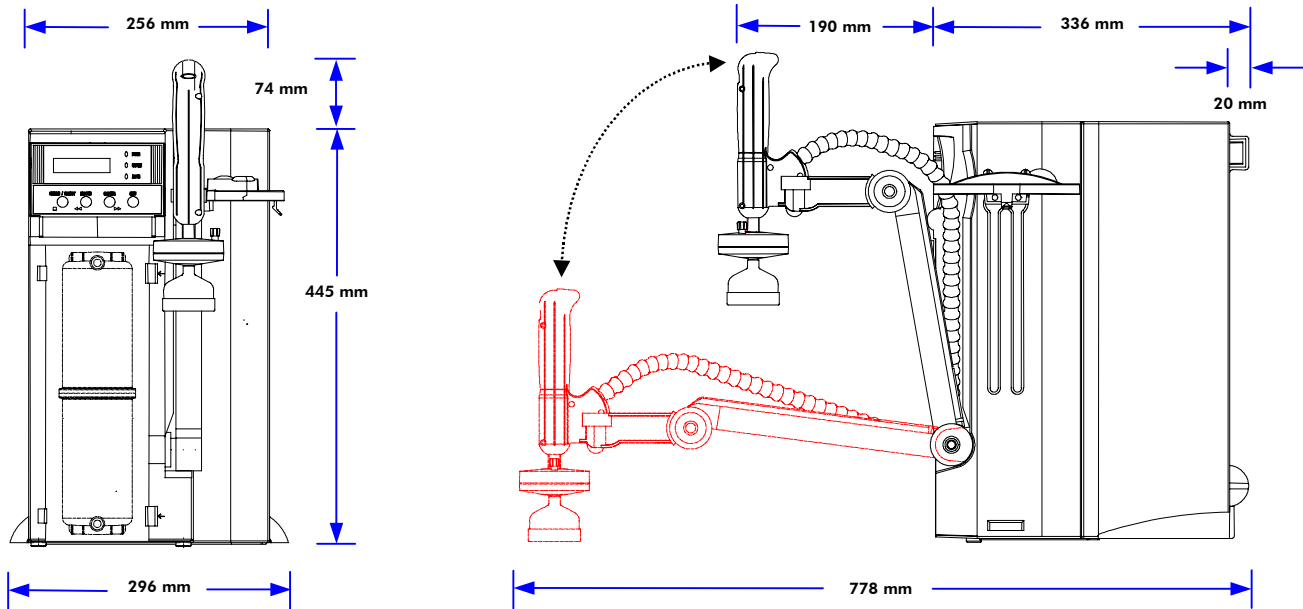

WEIGHT

- Milli-Q Gradient: Operating weight (wetted Q-Gard, Quantum and Millipak): 16 kg.
- Milli-Q Gradient A10: Operating weight: 16.8 kg.

ELECTRICAL

- The electrical requirements for a Milli-Q Gradient (or Milli-Q Gradient A10) are:
 - 120 VAC ± 10%, 50/60 Hz, 100 VA, 0.5 amp source, 2 amp Time Lag fuse used (ref. ZMQS6VOT1, ZMQP6VOT1, ZMQS6V001, ZMQP6V001).
 - 230 VAC ± 10%, 50/60 Hz. 0.26 amp source, 1 amp Time Lag fuse used (ref. ZMQS5VOT1, ZMQP5VOT1, ZMQS5V001, ZMQP5V001).
- The source of electrical power should be within 1 meter of the Milli-Q. The source of electrical power must be earth grounded.

MEASUREMENT RANGES FOR TOC, RESISTIVITY, CONDUCTIVITY AND TEMPERATURE

The Milli-Q can display various Product Water quality parameters. The range of measurement of each parameter is written below.

Resistivity Measurement Range:	2.4 – 18.2 MΩ.cm (compensated to a 25°C value)
Conductivity Measurement Range:	0.055 – 0.294 μS/cm
Temperature Measurement Range:	0 – 45°C (not the system temperature operating range)
TOC Measurement Range:	1 – 999 ppb

MATERIALS OF CONSTRUCTION

Please contact Millipore for a list of the materials of construction for wetted components.

NOISE LEVEL

The Milli-Q has a noise level of 42 dB at a distance of 1 meter away.

Chapter 3 **PRE INSTALLATION**

3-1 **PRE INSTALLATION CHECKLIST**

The installation of your Milli-Q will go much easier if certain pre installation requirements are met and followed.

The checklist below can be used to facilitate the pre installation of your Milli-Q system. You can refer back to this checklist as you read the sections on Optional Equipment, Installation Requirements and Unpacking the Milli-Q Box.

- Do you have a Q-Gard Purification Pack?
- Do you have a Quantum Ultrapure Cartridge?
- Do you have a Millipak or BioPak?
- Do you have a Milli-Q and all items in its Accessories Bag?
- Do you have a source of electrical power close enough to the Milli-Q?
- Is the electrical source earth grounded?
- Are you feeding with a reservoir? (if feeding from a pressurised pipe, see below)
 - Is the reservoir full of water?
 - Is the source of water filling the reservoir fully operational?
 - Does the reservoir have an 8 mm tubing connection on one of its valves?
- Are you feeding the Milli-Q from a pressurised pipe (loop)?
 - Do you have a pressure regulator ready to connect between the pipe and the Milli-Q?
 - Is the water system feeding the pipe fully operational?
 - Does the pipe have a valve ending with a 1/2 inch NPTM connection? If not, do you have a fitting or connection that will attach to the pipe and will end in a 1/2 inch NPTM connection?
 - Is there a way to shut off water from the pipe to the Milli-Q? If not, did you order a ball valve from Millipore to install on the Feedwater Tubing?
- Are you mounting the Milli-Q on a wall?
 - A wall mounting bracket may be needed in specific conditions
 - Will the wall support the weight of the Milli-Q (plus full reservoir,...)?
 - Is the Milli-Q accessible at this height (viewing the LCD, using the keypad)?
- Did you include space on the right side of the Milli-Q to remove and replace the Q-Gard?
- Did you want a location so as to dispense water over a sink?
- Is the Milli-Q located within 2.5 meters of a drain (for the Feedwater Pressure Relief Valve tubing)?
- Are the room environmental conditions adequate (humidity, temperature)?
- If you are going to connect a printer or computer to the Milli-Q later, did you leave room for this?
- If you are using a footswitch accessory to control the Milli-Q, did you leave room for this?

3-2 PRE INSTALLATION CHECKLIST – «ARMLESS» MILLI-Q

Milli-Q Systems can be ordered from Millipore without the Front Arm and without the Front Point Of Use Dispenser. These are called «Production» or «Armless» Milli-Q Systems. These Milli-Q Systems always begin with ZMQP instead of ZMQS.

When a «Production» Milli-Q is ordered (you ordered Millipore Catalogue Number ZMQP ... for example), the Milli-Q arrives in a box without a Front Arm and without a Front Point Of Use Dispenser.

It is necessary to have a Remote Point Of Use Dispenser with these types of Milli-Qs. Section 3-3 of this manual has more information regarding the Remote Point Of Use Dispenser.

It may be desired to have Remote Display with the «Production» Milli-Q System. An example of when this would be needed is when the Milli-Q System is being mounted underneath a Lab Bench. In this instance, the Remote Display (and Remote Point Of Use Dispenser) could be mounted on top of the Lab Bench.

When you have a «Production» type of Milli-Q System, use the same Pre Installation Checklist on the previous page. Additionally, you should review the items below also.

- Do you have a Remote Point Of Use Dispenser (this item is not part of a ZMQP Millipore Catalogue Number)?
- Do you have a Remote Display (this item is not part of a ZMQP Millipore Catalogue Number)?
- Will the Milli-Q System Cabinet and the Remote POU Dispenser be located within 2.5 meters of each other?
- Will the Milli-Q System Cabinet and the Remote Display be located within 2.4 meters of each other?

3-3 OPTIONAL EQUIPMENT YOU MAY NEED

WALL MOUNTING BRACKET

The Millipore Catalogue Number for a Wall Mounting Bracket is SYSTFIX01. The mounting hardware for attaching the bracket to a wall is not included and must be supplied. The bracket is attached with at least 2 bolts (or screws).

Width of bracket = 23 cm Height of bracket = 5.4 cm

Thickness of bracket = 0.4 cm Diameter of holes in the bracket for bolts or screws = 0.7 cm

Mounting holes on bracket are approximately 5.4 cm from either edge

PRESSURE REGULATOR

The Millipore Catalogue Number for a Pressure Regulator (with Pressure Gauge and 8 mm tubing connections) is ZFMQ000PR.



It is important that the Pressure Regulator is adjusted while water is flowing through it. A range between 0.1 bar and 0.3 bar (1.5 to 4.5 psi) is the normal setting of the Pressure Regulator while water is being dispensed from the Milli-Q. The Pressure Regulator is factory pre-set to 0.3 bar while water at 80 LPH is flowing through it.

BALL VALVE FOR SHUTTING OFF THE FEEDWATER SUPPLY

It is highly recommended to use a Ball Valve on the Feedwater Tubing. The Ball Valve will be used to shut off the feedwater supply if necessary.

Contact Millipore for information regarding the Ball Valve. It is usually necessary to have fittings installed on both ends of the Ball Valve to be able to connect it to the Feedwater Tubing.

REMOTE POINT OF USE DISPENSER

A Remote POU Dispenser can be added to the Milli-Q. This allows you to dispense water a maximum distance of 2.5 meters away from the Milli-Q. The Remote POU Dispenser is rested on a moveable arm that allows 180° rotation.

The Millipore Catalogue Number for a Remote POU Dispenser (plus arm and weighted base) is ZMQSP0UR1. It is also necessary to order an installation kit with the Remote POU Dispenser. This Installation Kit has a Millipore Catalogue Number of ZMQSP0U01.

The Remote POU Dispenser can be either wall mounted or set on a benchtop. The installation instructions for the Remote POU Dispenser are included with it.

REMOTE POINT OF USE DISPENSER USED ON A «PRODUCTION» TYPE MILLI-Q

A «Production» type Milli-Q System needs to have a Remote Point Of Use Dispenser added to it. Without one, you would not be able to dispense water from the Milli-Q.

All of the information in the above section («Remote Point Of Use Dispenser») applies to a «Production» type of Milli-Q System. You will not need to order the Installation Kit however. The items in the Installation Kit are Factory installed on «Production» Milli-Q Systems.



Do not order Installation Kit Catalogue Number ZMQSP0U01 when you have a Milli-Q System beginning with a ZMQP Catalogue Number.

FOOTSWITCH

The Millipore Catalogue Number for the Footswitch (plus cable) is ZMQSFTS01. The Footswitch allows you a 'hands free' operation where you could change the Milli-Q from PRE OPERATE Mode to PRODUCT Mode. The length of the Footswitch Cable is 5 meters. You will use about 0.3 meters of the Footswitch Cable inside the Milli-Q.

PRINTER OR COMPUTER CABLE

The Millipore Catalogue Number for the Printer Cable is PRNTCBL01. Its length is 2.79 meters.

The Millipore Catalogue Number for the Computer Cable is COMPCBL01. Its length is 1.65 meters.

You will use about 0.6 meters of either cable for its connection inside the Milli-Q cabinet.

REMOTE DISPLAY WITH KEYPAD

The Millipore Catalogue Number for a Remote Display is ZMQSRMDS1. The Remote Display allows you to view the LCD and to use the Keypad Buttons remotely.

The dimensions of the Remote Display are length = 204 mm, height = 112 mm and depth = 48 mm. Its weight is 613 g.

The Remote Display comes with a 3 meter cable that plugs into the Milli-Q System inside. You will use about 0.6 meters of the cable inside the Milli-Q.

The Remote Display can be wall mounted. There are 2 stainless steel brackets that are attached to either side of the Remote Display. These brackets can be fastened to the wall. The Hardware necessary to attach these brackets to a wall (i.e. screws, bolts) does not come with the Remote Display.

The instructions for installing the Remote Display are inside its shipping box. The instructions for installing a Remote Display are not inside this manual. Contact Millipore for these instructions if you would like to see them before obtaining the Remote Display.

PRE INSTALLATION

FOOTSWITCH



WALL MOUNTING BRACKET

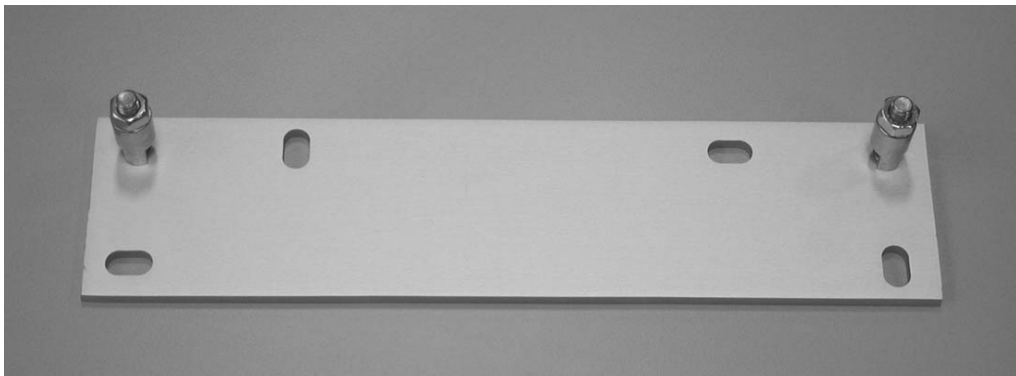

BALL VALVE

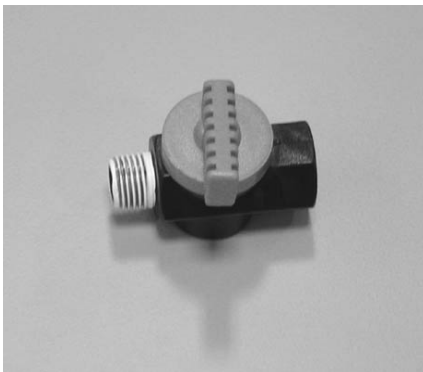

PRESSURE REGULATOR



REMOTE DISPLAY

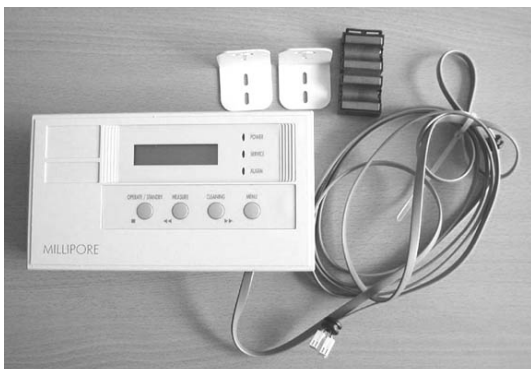

REMOTE POU DISPENSER



3-4 INSTALLATION REQUIREMENTS

CONSUMABLES NEEDED FOR INSTALLATION

You will need one Q-Gard Pack, Quantum Cartridge and Millipak (or BioPak) for installation. These items do not come with the Milli-Q system. These items need to be ordered separately. The Catalogue Numbers and options for these items are written below.

Some of the items below can be ordered as part of a kit. An example might be a kit consisting of a particular type of Quantum Cartridge plus a Millipak Express 20. See Section 8-1 for the catalogue numbers and descriptions of various kits.

See Section 2-3 for technical information regarding the Consumables for a Milli-Q system.

Q-Gard Purification Pack

- ⇒ Q-Gard 1 QGARD00R1 1/box (RO, Elix, distilled, Milli-RX, Milli-RO feedwater)
- ⇒ Q-Gard 2 QGARD00D2 1/box (DI, Service DI feedwater)

Quantum Ultrapure Cartridge

- ⇒ Quantum IX QTUM000IX 1/box (*100% ion exchange resin*)
- ⇒ Quantum EX QTUM000EX 1/box (*Ion exchange resin + media for organics removal*)
- ⇒ Quantum VX QTUM000VX 1/box (*Volatile organics removal + ion exchange resin*)

Quantum Ultrapure Cartridge with 1 non sterile Millipak 20 Express

- ⇒ Quantum IX QTUMMPEIX 1/box
- ⇒ Quantum EX QTUMMPEEX 1/box

Millipak 40 Final Filter

- ⇒ Millipak 40 (sterile) MPGL04SK2 2/box

Millipak Express 20 Final Filter

- ⇒ Millipak Express 20 (non sterile) MPGP02001 1/box

BioPak Ultrafiltration Cartridge

- ⇒ BioPak CDUFB1001 1/box (instructions included)

SPACE AND WEIGHT REQUIREMENTS

See Section 2-4 for a drawing showing the dimensions of a Milli-Q.

- Total **Height** needed (includes POU Dispenser being fully upright): 53 cm
- Total **Width** needed (includes room needed to remove Q-Gard): 45 cm
- Total **Depth** needed (includes POU when it is fully upright): 53 cm
- **Operating weight** for a 'wet' Milli-Q Gradient (Gradient A10): 16 kg (16.8 kg)

ELECTRICAL REQUIREMENTS

- The electrical requirements for a Milli-Q Gradient (or Milli-Q Gradient A10) are:
 - 120 VAC \pm 10%, 50/60 Hz, 100 VA, 0.5 amp source, 2 amp Time Lag fuse used (ref. ZMQS6V0T1, ZQMP6V0T1, ZMQS6V001, ZMQP6V001).
 - 230 VAC \pm 10%, 50/60 Hz. 0.26 amp source, 1 amp Time Lag fuse used (ref. ZMQS5V0T1, ZMQP5V0T1, ZMQS5V001, ZMQP5V001).
- The source of electrical power should be within 1 meter of the Milli-Q. The source of electrical power must be earth grounded.

FEEDWATER REQUIREMENTS

Feedwater Conductivity:	< 100 μ S/cm @ 25°C
Feedwater Flowrate:	The source of feedwater should deliver \geq 1.5 LPM
Maximum Feedwater pressure:	\leq 0.3 bar (use a Pressure Regulator if necessary)
Minimum Feedwater Pressure:	\geq 0.0 bar (i.e. reservoir \leftrightarrow same level as the Milli-Q)
Feedwater temperature:	Between 5°C and 35°C

Items to note about feedwater:

- The ion exchange capacity of the Q-Gard Purification Pack and the Quantum Ultrapure Cartridge are a strong function of the conductivity and the dissolved CO₂ gas level of the feedwater source.
- The Fouling Index (Silt Density Index) of the Feedwater, when > 5, can effect the ability of the Ion Exchange Resin to remove ions.
- The TOC level of the Milli-Q Product Water could be affected by the type of feedwater.

Contact Millipore for additional information regarding the 3 items noted just above.

It is highly recommended to use a feedwater source treated by RO or EDI. Millipore RiOs or Elix Water Purification Systems are examples of RO or EDI feedwater sources respectively.

ENVIRONMENTAL REQUIREMENTS

Indoor use only

Storage and operating temperature:	5°C < T < 40°C
Humidity:	Should not exceed 80% for temperatures below 31°C. Should stay within 50% to 80% between 31°C and 40°C.
Altitude:	< 2000 Meters
Installation category:	II
Pollution degree:	2

OTHER REQUIREMENTS

Reservoir is the feedwater source

If you are using a reservoir as the feedwater source, then you will need a Ball Valve on the reservoir. This Ball Valve is normally supplied on the standard Millipore 30 Litre or 60 Litre or 100 Litre Reservoirs.

The end of the Ball Valve should terminate with a fitting that accepts 8 mm tubing. This fitting is not supplied on the standard Millipore 30 Litre or 60 Litre or 100 Litre Reservoirs. You can order a fitting from Millipore with a 1/4 inch NPTM connection on one end and an 8 mm tubing insert on the other.

Contact Millipore if your reservoir has another thread size on the port you want to use for the feedwater connection to the Milli-Q.

3-5 UNPACKING THE MILLI-Q BOX – WHAT’S INSIDE?

Open the Milli-Q Shipping Box. Use the checklist and illustrations below to make sure all items were shipped and are accounted for. It is highly suggested to become familiar with the items that are shipped in the accessories bag since these will be used in the Installation Section of this manual.

Check the box if the item is present.

Contact Millipore if an item is missing.

Do you have...?

- Milli-Q Water Purification System
- Electrical Powercord

Inside the accessories bag:

- Black tubing (8 mm OD) about 2.5 meters in length. An assembly of blue fittings is attached to one end of this tubing. The assembly of blue fittings has a Screen Filter inside. The term 'Screen Filter' will be used for the remainder of this manual to refer to the assembly of blue fittings.
- Fitting (1/4 inch NPTM on one end and a hose barb on the other end)
- Clear Tygon tubing
- Roll of Teflon tape
- 2 Elbow shaped fittings (black with yellow coloured collar)
- 'Allen' Wrench (6-sided black wrench)
- Clear tubing (6 mm OD) about 2.5 meters in length

ACCESSORIES



Chapter 4 INSTALLATION

4-1 CONNECTING TO A SUPPLY OF FEEDWATER

FEEDWATER IS FROM A RESERVOIR

- ❑ Make sure the Reservoir is full of purified water (i.e. RO or Elix water). Make sure the Milli-Q is located either beside or lower than the Reservoir. It is not advisable to locate the Reservoir below the Milli-Q.
- ❑ If you are using a 30 or 60 or 100 Litre Reservoir from Millipore, then install a connector fitting which is 1/4 inch NPTM on one end and has an 8 mm tubing insert collar on the other end. This connector fitting should be installed on the middle valve located on the bottom side of the 30/60/100 Litre Reservoir. The Millipore fitting referenced above has an O-ring on its thread. You will not need to use Teflon Tape on this fitting. Simply screw this connector into place.
- ❑ Measure the distance between the Reservoir and the back of the Milli-Q. Allow some extra distance so the Milli-Q could be rotated or moved without stretching the tubing. Cut an appropriate sized length of the black 8 mm OD tubing.
- ❑ Install one end of this tubing to the Reservoir. Push one end of the tubing into the collar of the fitting until it will go no further. Pull on it slightly to insure it is fully seated inside the collar.

FEEDWATER IS FROM A PRESSURISED SOURCE SUCH AS A PIPE (A LOOP)

- ❑ Get the roll of Teflon Tape and the 8 mm tubing (plus Screen Filter) from the Accessories Bag. Make sure that the pipe end is a 1/2 inch NPTM connection. If this connection is not ready, then you will need to obtain the proper fittings to be able to attach the fittings from the Milli-Q Accessories Bag.
- ❑ Wind about 3 to 4 turns of Teflon Tape on the end of the pipe connection. The tape should be wound in a clockwise direction (same direction the fittings will be turned).
- ❑ Screw the Screen Filter to the end of the pipe. You may want to remove the attached 8 mm tubing to facilitate the turning of the Screen Filter Assembly.
- ❑ Measure the distance needed for the Feedwater Tubing. This is the distance between the Screen Filter and the back of the Milli-Q. Allow some extra distance so the Milli-Q could be rotated or moved without stretching the tubing.
- ❑ Cut the appropriate length of 8 mm tubing as determined above.
- ❑ You will now need to install the Feedwater Pressure Regulator (Millipore Catalogue Number ZFMQ000PR). Locate the Pressure Regulator. Turn it over so you can see the arrow that indicates the direction of water flow through the Pressure Regulator. **It is important not to reverse the water flow through the Pressure Regulator.**
- ❑ The Pressure Regulator is installed between the Screen Filter (now attached to the pipe end) and the back of the Milli-Q.
- ❑ You will check and/or set the Pressure Regulator later (see Section 4-7 below). Normally, the Millipore Pressure Regulator is pre-set to 0.3 bar and will not need adjustment.
- ❑ You may want to flow some feedwater through the tubing and Pressure Regulator to check for leaks.

CONNECTION TO A PRESSURISED PIPE

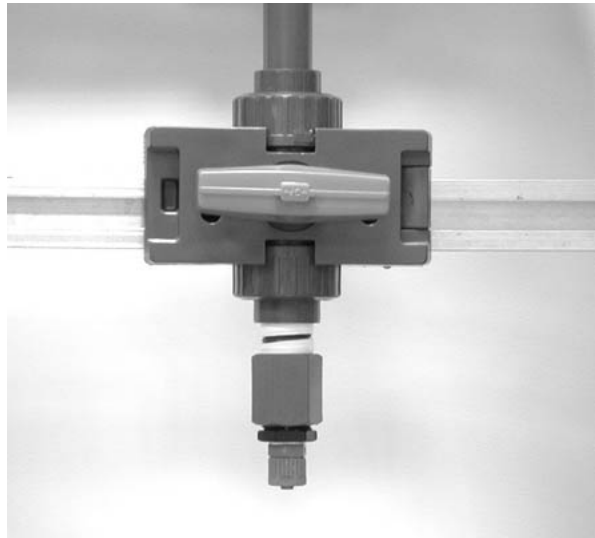
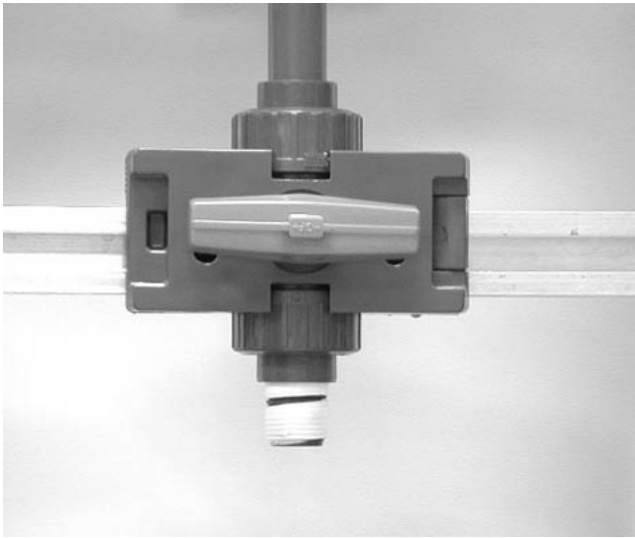

4-2 CONNECTION OF TUBING AND THE POWERCORD

FEEDWATER TUBING

- ❑ Rotate the Milli-Q so you can see the back of the system cabinet.
- ❑ Look below the place where the Powercord would be plugged in. You will see some holes ('ports') where tubing can be plugged in. The large ports are 8 mm in OD. The smaller ports are 6 mm in OD. Locate the left side 8 mm Port labelled as FEED 1 (this lettering is located just above the collar of the port). It may be difficult to see unless you are close to the system.



Make sure the Feedwater Tubing is connected to the FEED 1 Port. Make sure the Feedwater Tubing is not connected to the DRAIN 3 Port (the right side 8 mm OD Port).

- ❑ Remove the red plug that is in the FEED 1 Port. To do this, push in on the collar that holds the plug in-place. At the same time pull the red plug out.
- ❑ Locate the elbow shaped fitting from the Accessories Bag. Install it into the FEED 1 Port. Push it in all the way. The use of this elbow fitting will allow the tubing to fit better especially if the system is wall mounted.
- ❑ Plug the Feedwater Tubing into the elbow fitting installed in the FEED 1 Port. If your feedwater is from a reservoir, then plug in the end of the tubing that is originally attached to the bottom of the Reservoir. If your feedwater is from a Pressurised Pipe, then plug in the end of the tubing that is initially attached to the outlet of the Pressure Regulator.

FEEDWATER PRESSURE RELIEF TUBING

This procedure does not need to be done if the Milli-Q is being fed from a Reservoir. It is highly recommended to perform this procedure if the Milli-Q is being from a pressurised source such as a loop.

- ❑ Locate the roll of clear 6 mm OD tubing that came in the Accessories Bag.
- ❑ Locate the smallest elbow shaped fitting from the Accessories Bag.
- ❑ Locate the OUT 5 Port on the back of the Milli-Q Gradient (or Milli-Q Gradient A10) system.
- ❑ Install the 6 mm Elbow into the OUT 5 Port. Push it in all the way. The use of this elbow fitting will allow the tubing to fit better especially if the system is wall mounted.
- ❑ Plug the clear 6 mm OD tubing into the elbow fitting.
- ❑ Place the other end of the clear 6 mm OD tubing into a sink or drain. Shorten the tubing if necessary.

CONNECTING THE POWERCORD

- ❑ Locate the Milli-Q Power Switch. It is located on the back of the system cabinet. It is located just above the Feedwater Tubing connection.
- ❑ Make sure your Milli-Q System Power Switch is in the 'OFF' position. The Power Switch is off when the 'O' position is selected.
- ❑ Plug the Powercord into the Milli-Q. It plugs in next to the Power Switch.
- ❑ Plug the other end of the Powercord into an appropriate source of electrical power (i.e. wall outlet).

FEEDWATER TUBING CONNECTION

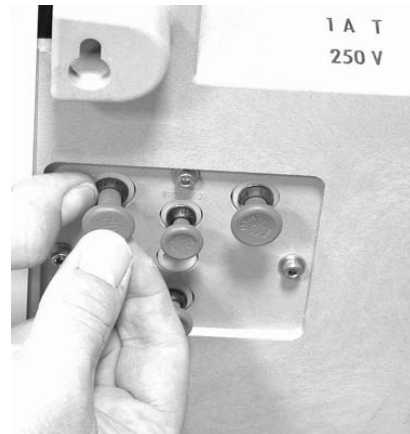
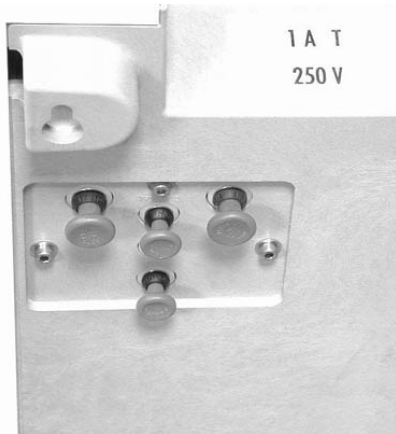

PRESSURE RELIEF TUBING CONNECTION

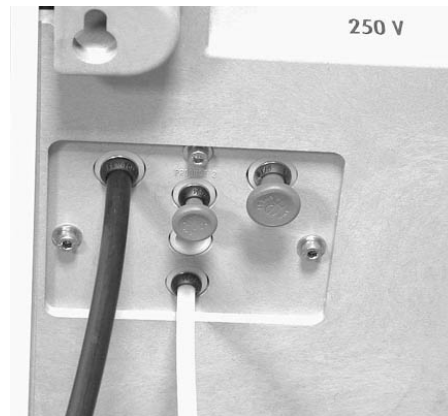
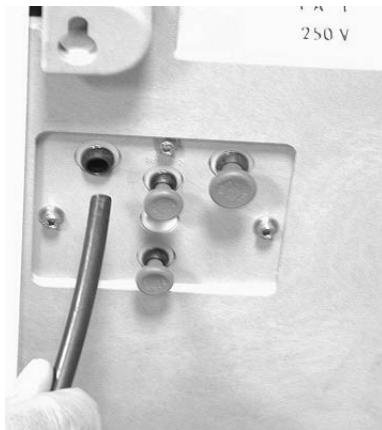

POWERCORD CONNECTION

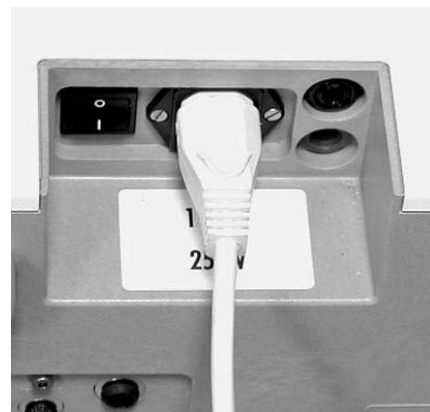
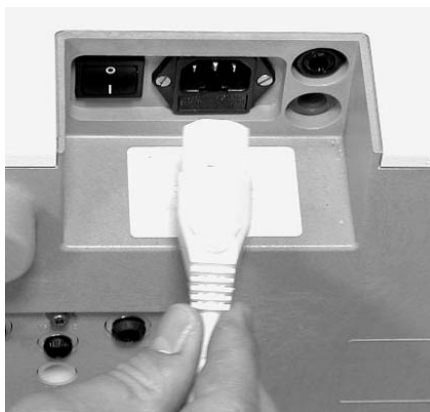

4-3 INSTALLATION OF THE Q-GARD

- ❑ Make sure the electrical power is off to the Milli-Q system.
- ❑ The Q-Gard is installed on the Milli-Q front right side. Locate the white Q-Gard Pack Adapter Lid. **Look below the lid and locate the 2 yellow plastic inserts.** Pull them out and remove them.
- ❑ Remove the Q-Gard from its shipping box. Verify the Millipore Catalogue Number by looking at the sticker on top of the Q-Gard. The sticker should be blue. Remove the plastic covers on the 2 ports of the Q-Gard Pack. Look inside the ports to locate the black rubber O-rings. Make sure these are pushed in so they are firmly in place.
- ❑ Wet the Q-Gard O-rings with water. It is preferable to wet them with ultrapure water. **DO NOT WET THE O-RINGS WITH A LUBRICANT SUCH AS OIL OR SILICON GREASE.**
- ❑ Locate the small protruding piece of plastic near the bottom of the Q-Gard. Push this into the small hole in the Milli-Q Cabinet. This will aid in holding the Q-Gard Pack upright.
- ❑ Push the Q-Gard Pack onto the Pack Adapter. The Q-Gard Pack rubber O-rings will be making a water tight seal. It is important that the Q-Gard is pushed in fully. **The notch on the end of the metal rod on the Pack Adapter should come through the hole on the Q-Gard Pack.**
- ❑ Locate the Metal Clip that is attached to the Pack Adapter with a piece of filament wire. Push the Metal Clip onto the notch of the metal rod (see the step above). The top of the Metal Clip should bend towards you. This will allow you to easily remove it when the Q-Gard is replaced later.

The Q-Gard is now installed.

4-4 TURNING ON THE SYSTEM POWER

- ❑ Turn on the Milli-Q system electrical power. The Power Switch is located on the rear of the Milli-Q system cabinet. The 'I' is the 'on' position of the Power Switch.
- ❑ Make sure the POU Dispenser Trigger is in the upright position.

When the system power is on but the Quantum Cartridge is not installed, the LCD should look like:

NOTE: The display messages may be in English on your Milli-Q system (go to Section 4-12 to change your display language).

GRADIENT	V3.03
SR.NO	F1PN64537

System type, software version and serial number displayed for about 10 seconds

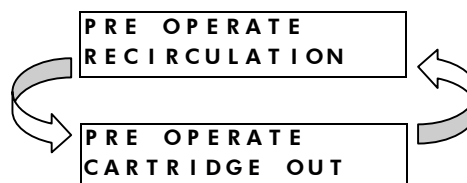

The RECIRCULATION display appears for only 5 minutes

The Red ALARM LED will be flashing

4-5 INSTALLATION OF THE QUANTUM CARTRIDGE

- ❑ Locate the 2 latches on the front door of the Milli-Q Cabinet. Push each latch to the left and then open the door.
- ❑ Remove the 2 yellow plastic inserts that are inside. Pull them out and remove them.
- ❑ Remove the Quantum Cartridge from its shipping box. Confirm that you have the desired type of Quantum Cartridge by viewing the label on the top of the Quantum Cartridge.
- ❑ Remove the 2 plastic covers on the ports of the Quantum Cartridge. There should be a black rubber O-ring in each port. Make sure these are pushed firmly in place.

INSTALLATION

INSTALLATION OF THE Q-GARD PACK

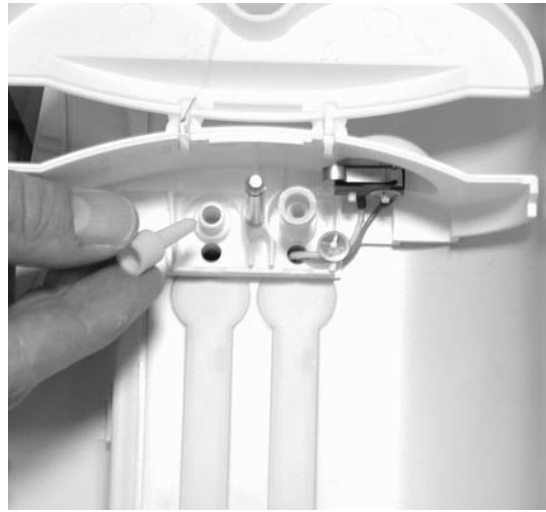

INSTALLATION OF THE QUANTUM CARTRIDGE



- ❑ Wet the Quantum Cartridge O-rings with water. It is preferable to wet them with ultrapure water. **DO NOT WET THE O-RINGS WITH A LUBRICANT SUCH AS OIL OR SILICON GREASE.**
- ❑ Push the Quantum firmly into place. Both the top and bottom ports of the Quantum Cartridge have to be fully seated.
- ❑ Close the door.



Make sure that both the top latch and the bottom latch of the door are fully closed. Each latch should 'click' when it is fully closed.

The Quantum Cartridge is now installed.

4-6 INSTALLATION OF THE TYGON TUBING

- ❑ Locate the clear Tygon Tubing and the Barbed Fitting from the Accessories Bag.
- ❑ Screw the Barbed Fitting onto the bottom end of the POU Dispenser.



Do not use any Teflon Tape on the threads of the Barbed Fitting. An O-ring is located inside the POU Dispenser to insure water tightness between the threads of the POU Dispenser and the Barbed Fitting.

- ❑ Push one end of the Tygon Tubing onto the end of the Barbed Fitting. Place the other end of the Tygon Tubing in a sink.

4-7 PURGING THE AIR FROM THE SYSTEM

- ❑ At this time you should have installed the Q-Gard Pack, Quantum Cartridge, Barbed Fitting and the Tygon Tubing. The system power should be on. The POU Dispenser Trigger should be upright. The LCD should be showing PRE OPERATE.
- ❑ Verify that you have several Litres (> 15 Litres) of feedwater (i.e. full Reservoir or full Distribution Loop).
- ❑ Open any valves on the feedwater supply (i.e. valve on the bottom of the Reservoir).
- ❑ Bring the POU Trigger down (towards you). You should hear a sharp 'click' noise. This is the opening of the Inlet Solenoid Valve.
- ❑ The LCD will change and will look like:



- ❑ Let the AIR PURGE continue for its 5 minute duration. It will count down to 0 minutes (5, 4, ..., 0 mn).

- ❑ **Pressurised Feedwater Only:** Check the Pressure Gauge on the Pressure Regulator. While water is flowing through it, the Pressure Gauge should show 0.3 bar. If it is not set to 0.3 bar, then turn the round handle on the Pressure Regulator clockwise until the pressure gauge (on the regulator) shows 0.3 bar. Check this again when water is flowing through the Pressure Regulator.



The setting of the Pressure Regulator should not exceed 0.3 bar. The feedwater pressure reaching the Milli-Q in PRODUCT Mode should not exceed 0.3 bar. The Pressure Regulator should only be set while water is flowing through it. It is perfectly normal to see an increase in the Pressure Regulator setting while water is not flowing through it (i.e. STANDBY or PRE OPERATE Mode).

- ❑ The Milli-Q will now go to STANDBY Mode and will remind you to close the POU Dispenser Valve.
- ❑ Move the POU Dispenser Trigger back (its upright position). The Milli-Q will now go to PRE OPERATE Mode.

STANDBY
CLOSE THE VALVE



PRE OPERATE

- ❑ **Milli-Q Gradient A10 only** When you 'Close The Valve', the Milli-Q will go to PRE OPERATE Mode and then will start an automatic 60 minute A10 CLEANING. The A10 CLEANING is a way of flushing out any particles that may have been present in the newly installed Q-Gard Pack or Quantum Cartridge.

STANDBY
CLOSE THE VALVE



PRE OPERATE
A10 CLEANING: 60

- ❑ **Milli-Q Gradient A10 only:** Allow the A10 CLEANING to count down to 0 minutes.

The remaining steps of this section apply to both the Milli-Q Gradient and the Milli-Q Gradient A10.

- ❑ Any remaining air in Quantum Cartridge can be 'hand purged' out now.
- ❑ Get a screwdriver with a very thin shaft and small head.
- ❑ Locate the small hole on the top part of the Quantum Cartridge Door.
- ❑ **Gently** insert the screwdriver into the Quantum Cartridge. This will open a small vent that will expel any air in the Quantum Cartridge.



Be very careful when pushing the tip of the screwdriver into the Vent Hole of the Quantum Cartridge. The Vent Hole only needs to be opened a very small amount.

- ❑ If all of the air does not expel out, do not worry. You can repeat this step later after more water has flowed through the Milli-Q. Remember to have the Milli-Q in STANDBY or PRE OPERATE Mode while you are expelling air out of the Quantum Cartridge.

4-8 HYDRATING THE SYSTEM

- ❑ At this time, the Millipak (or BioPak) is not installed. The Barbed Fitting and Tygon Tubing should still be attached to the end of the POU Dispenser.
- ❑ Leave the Milli-Q in PRE OPERATE Mode overnight or for several hours. This will aid in rinsing off the purification media inside the Q-Gard Pack and the Quantum Cartridge. Do not leave the Milli-Q in STANDBY Mode.
- ❑ (The next morning) Bring the POU Dispenser Trigger forward to put the Milli-Q into PRODUCT Mode.
- ❑ Allow about 10 to 15 Litres (about 7 to 10 minutes) of water to be dispensed from the Milli-Q.
- ❑ Bring the POU Dispenser Trigger upright. The Milli-Q will finish dispensing water. The Milli-Q will continue to operate for 90 seconds after which it will go into PRE OPERATE Mode.
- ❑ Leave the Milli-Q in PRE OPERATE Mode.

INSTALLATION

INSTALLATION OF BARBED FITTING AND TYGON TUBING

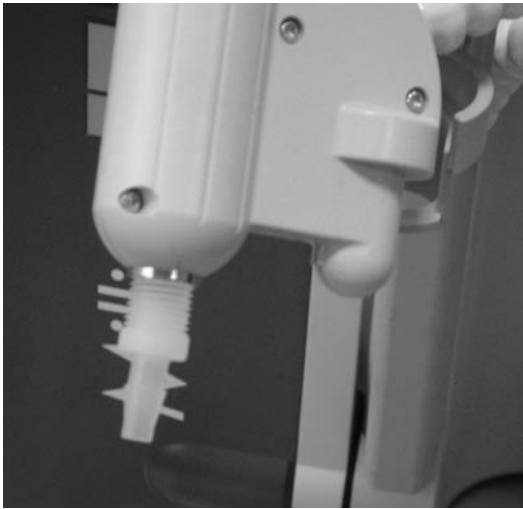

PURGING AIR FROM THE QUANTUM CARTRIDGE



INSTALLATION AND AIR PURGE OF THE MILLIPAK



4-9 INSTALLATION AND RINSING OF THE MILLIPAK

- ❑ Obtain a Millipak.
- ❑ Remove the Tygon Tubing and the Barbed Fitting from the POU Dispenser.
- ❑ Screw the Millipak onto the POU Dispenser. **Do not use any Teflon Tape on the threads of the Millipak. The Millipak should be turned until it is handtight. Do not overtighten the Millipak.**



Do not use Teflon Tape on the threads of the Millipak. The POU Dispenser has an O-ring inside which provides a watertight seal.

- ❑ Move the POU Dispenser Trigger forwards. This will bring the Milli-Q system into PRODUCT Mode.
- ❑ Locate the air vent valve on the top side (clear side) of the Millipak. Open this slowly but **do not remove it from the Millipak.** Allow any air on the clear side of the Millipak to be vented out.
- ❑ Dispense about 5 Litres of water. Make sure all air is purged out.



Air will not pass through the membrane filter in the Millipak. If there is trapped air in the Millipak, then a reduction in Product Water flowrate can result.

- ❑ Move the POU Dispenser Trigger back to the upright position. The Milli-Q should now be in PRE OPERATE Mode 90 seconds later. Leave the Milli-Q in PRE OPERATE Mode.



It is highly recommended not to put Tygon Tubing or any other type of tubing on the end of the Millipak. This can compromise the Product Water quality (bacteria can grow in the Tygon Tubing).

The Millipak is now installed and rinsed out.

4-10 INSTALLATION AND RINSING OF THE BIOPAK

Please refer to the Insert supplied with the BioPak.

4-11 HOW TO CALIBRATE THE FLOWRATE FROM THE MILLI-Q

It is possible to calibrate the flowrate of Product Water from the POU Dispenser.

- ❑ Make sure the Millipak or BioPak is vented of all trapped air.
- ❑ Make sure the Quantum Cartridge is vented of all trapped air.
- ❑ *Pressurised Feedwater only:* Make sure the Feedwater Pressure Regulator is set correctly between 0.1 bar and 0.3 bar.
- ❑ Make sure the Milli-Q is in PRE OPERATE Mode. If it is in STANDBY Mode, then press the OPERATE/STANDBY Keypad Button for about 2 seconds to go to PRE OPERATE Mode. If the Milli-Q is in PRODUCT Mode (dispensing water), then move the POU Dispenser Trigger back to the upright position.
- ❑ Press the MENU Keypad button for about 2 seconds. The LCD will change as shown here:

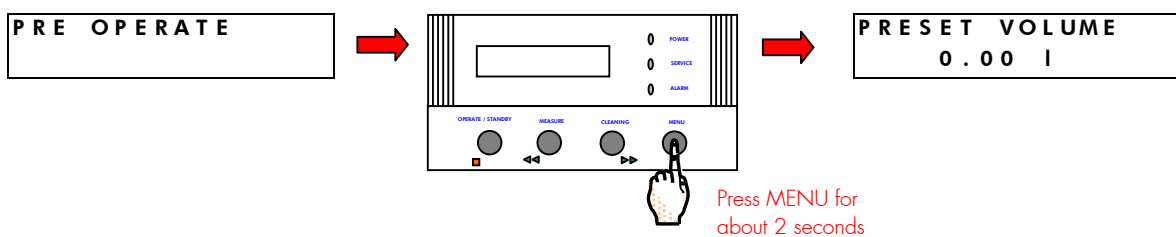

You have entered the 'Customer Service Software' of the Milli-Q.

If you do not see this display, then turn off, then on the system power. When the LCD shows PRE OPERATE and RECIRCULATION, press the STANDBY/OPERATE Keypad Button for about 2 seconds. This will place the Milli-Q into STANDBY Mode. Then press the STANDBY/OPERATE Keypad Button again. The Milli-Q will now be in PRE OPERATE Mode. Press the MENU Keypad Button again for 2 seconds to enter the Customer Service Software.

- ❑ Press the MENU Keypad Button 4 times. Stop when you see the FLOW MEASURE display.

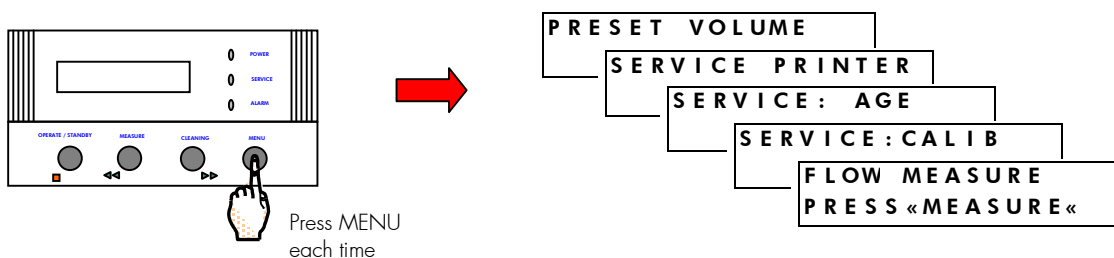

- ❑ Place a 2 L graduated cylinder under the Millipak or BioPak. If you do not have a 2 Litre graduated cylinder, then use a container that could hold up to 2 litres of water. Use an accurate measuring device to measure the total water that was dispensed from the Milli-Q.
- ❑ Bring the POU Dispenser Trigger down.

- Press the MEASURE Keypad Button.

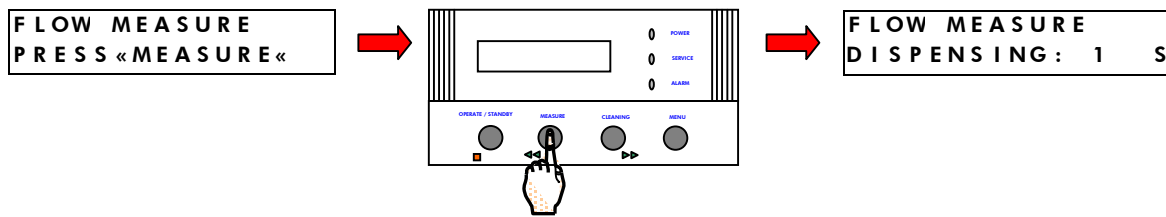

- The Milli-Q will dispense water for 60 seconds. Wait until this is finished. The timer will count up from 1 second to 60 seconds.
- When the 60 second timer is finished, the Flow Calibration Factor display will be shown. Measure the total volume of water (in Litres) dispensed from the Milli-Q. Use the Arrow Keypad Buttons (the MEASURE and CLEANING Keypad Buttons) to change the FLOW value to the amount of dispensed water.

In the example below, you measured 1.45 lpm. The flow measured during the manufacturing of the Milli-Q was 1.35 lpm.

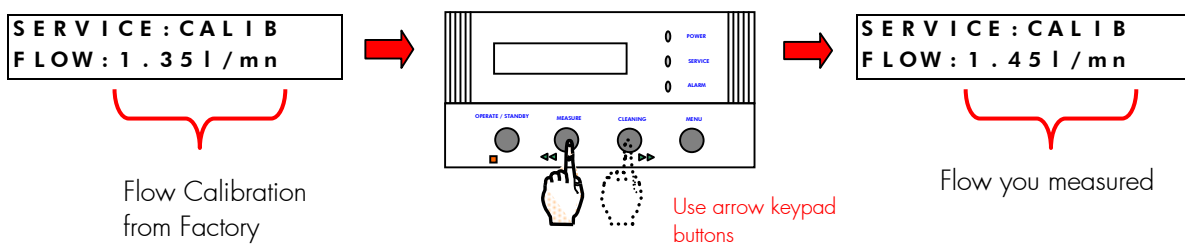

- Escape the Customer Service Software by pressing the MENU Keypad Button for about 2 seconds. You should be back to PRE OPERATE Mode.

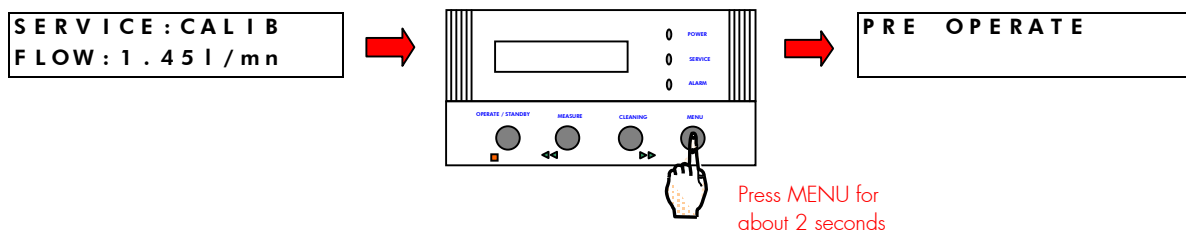

You have finished calibrating the Product Water Flowrate from the Milli-Q.

See the MAINTENANCE Chapter (see Chapter 6) of this manual to see when to perform a Flow Calibration.

4-12 HOW TO CHANGE THE DISPLAYED LANGUAGE

It is possible to have different languages displayed. These include English, French, Spanish, German, Italian, Japanese and Portuguese. If you change the displayed language, remember that the Customer Service Software remains in English.

Follow the steps below to change the displayed language.

- Press the MENU Keypad button for about 2 seconds. The LCD will change as shown here:

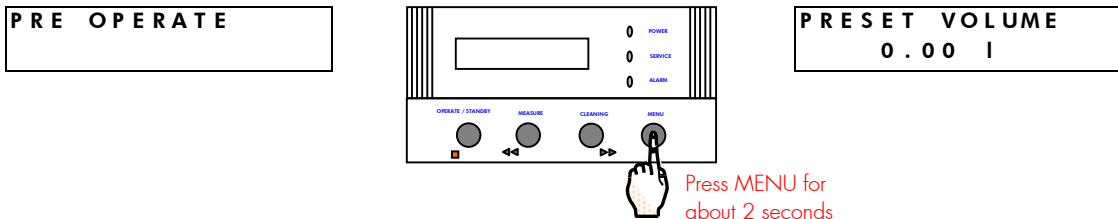

- You have entered the 'Customer Service Software' of the Milli-Q.

If you do not see this display, then turn off, then on the system power. When the LCD shows PRE OPERATE and RECIRCULATION, press the STANDBY/OPERATE Keypad Button for about 2 seconds. This will place the Milli-Q into STANDBY Mode. Then press the STANDBY/OPERATE Keypad Button again. The Milli-Q will now be in PRE OPERATE Mode. Press the MENU Keypad Button again for 2 seconds to enter the Customer Service Software.

- Press the MENU Keypad Button 5 times (6 times for a Milli-Q Gradient A10). Stop when you see the LANGUAGE (under SERVICE OPTIONS) display.

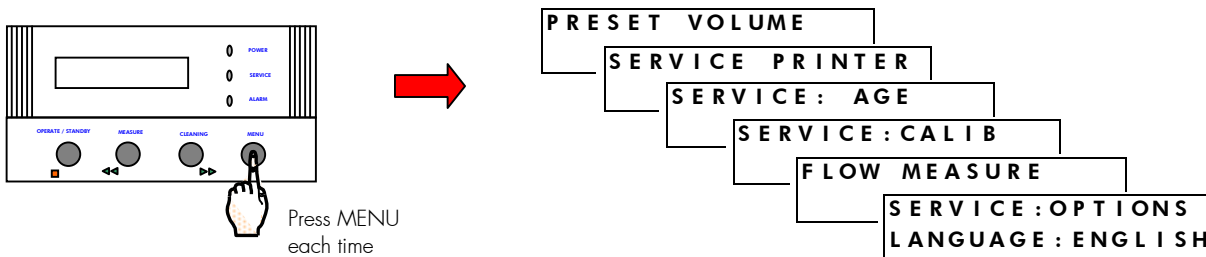

- Use the Arrow Keypad Buttons to change the language.
- Press the MENU Keypad Button for about 2 seconds to return to PRE OPERATE Mode.

SERVICE: OPTIONS
LANGUE: FRANCAIS

i.e. you want to see French

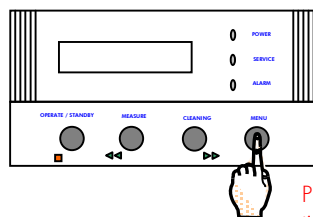

PAUSE

PRE OPERATE in French

You have finished changing the displayed language.

4-13 HOW TO SHOW EITHER $M\Omega.CM$ OR $\mu S/CM$ (RESISTIVITY OR CONDUCTIVITY UNITS)

It is possible to display Conductivity Units on the Milli-Q LCD. Conductivity ($\mu S/cm$) is the reciprocal of Resistivity ($M\Omega.cm$).

Follow the steps below to change from a Resistivity display to a Conductivity Display.

- Press the MENU Keypad button for about 2 seconds. The LCD will change as shown here:

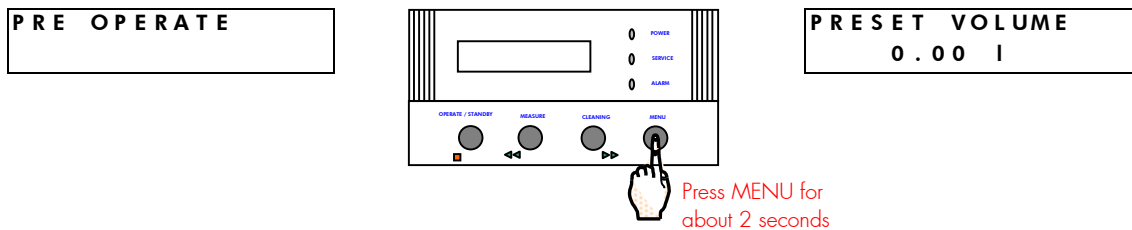

- You have entered the 'Customer Service Software' of the Milli-Q.

If you do not see this display, then turn off, then on the system power. When the LCD shows PRE OPERATE and RECIRCULATION, press the STANDBY/OPERATE Keypad Button for about 2 seconds. This will place the Milli-Q into STANDBY Mode. Then press the STANDBY/OPERATE Keypad Button again. The Milli-Q will now be in PRE OPERATE Mode. Press the MENU Keypad Button again for 2 seconds to enter the Customer Service Software.

- Press the MENU Keypad Button 5 times (6 times for a Milli-Q Gradient A10). You should press the MENU Keypad button each time. Stop when you see the LANGUAGE (under SERVICE OPTIONS) display.

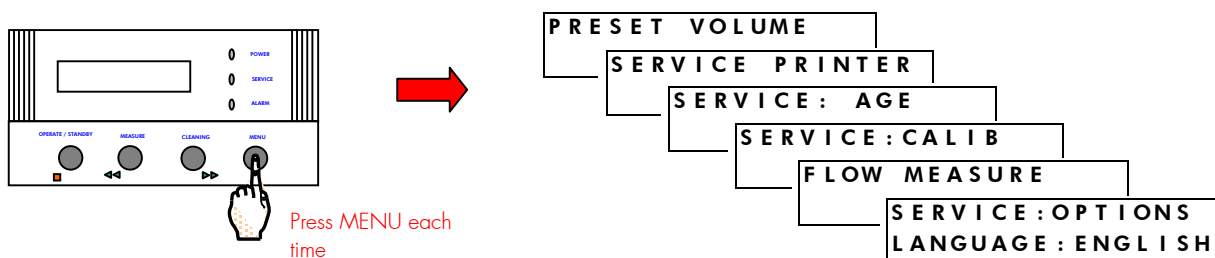

- Press the OPERATE/STANDBY Keypad once. The PROD. UNIT choice will be shown.

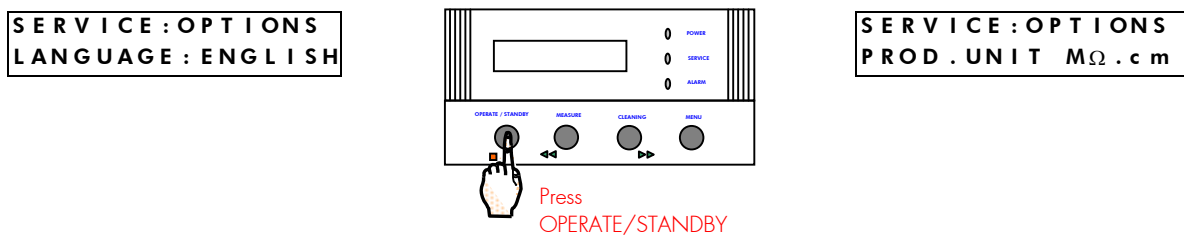

INSTALLATION

- Press the CLEANING Keypad Button to change the PROD. UNIT from $M\Omega.cm$ to $\mu S/cm$.

SERVICE : OPTIONS
PROD . UNIT $M\Omega . cm$

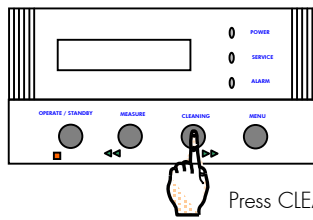

SERVICE : OPTIONS
PROD . UNIT $\mu S / cm$

Press CLEANING

- Press the MENU Keypad Button to return to PRE OPERATE Mode.

SERVICE : OPTIONS
PROD . UNIT $\mu S / cm$

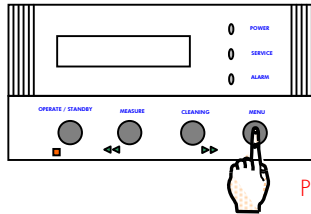

PRE OPERATE

Press MENU for
about 2 seconds

- When the Milli-Q is put into PRODUCT Mode, the LCD will look like:

PRE OPERATE → 0 . 055 $\mu S / cm$ @ 25 ° C
TOC : 4 ppb

Note that a Conductivity measurement of 0.055 $\mu S/cm$ is the same as a Resistivity measurement of 18.2 $M\Omega.cm$.

You have finished changing to units of Conductivity.

4-14 HOW TO SHOW NON TEMPERATURE COMPENSATED RESISTIVITY OR CONDUCTIVITY VALUES

It is possible to show non temperature compensated Resistivity or non temperature compensated Conductivity Product Water values on the LCD.

WHAT IS TEMPERATURE COMPENSATION?

Suppose the feedwater to a Milli-Q is 15°C. The Milli-Q Resistivity Sensor will measure a Resistivity Value of 31.756 MΩ.cm (or a Conductivity of 0.032 μS/cm). This is the actual Resistivity of the Milli-Q Product Water at 15°C.

The Milli-Q will perform a temperature compensation for the Resistivity measurement. It will be compensated to a measurement that would be seen at 25°C.

When a Resistivity measurement of 31.756 MΩ.cm @ 15°C is temperature compensated to a measurement at 25 °C, then the Milli-Q will display '18.2 MΩ.cm @ 25°C'.

Temperature compensation is a way of 'standardising' Resistivity or Conductivity to measurements that would be seen if the water temperature was 25°C.

Follow the steps below to display non temperature compensated Resistivity or Conductivity values.

- ❑ Choose whether you want to display Resistivity (MΩ.cm) or Conductivity (μS/cm). See Section 4-13 for information on how to change between these types of measurement units.
- ❑ Press the MENU Keypad button for about 2 seconds. The LCD will change as shown here:

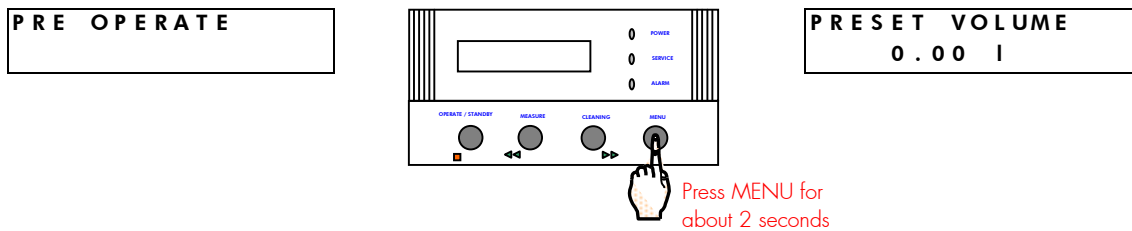

- ❑ You have entered the 'Customer Service Software' of the Milli-Q.

➔

If you do not see this display, then turn off, then on the system power. When the LCD shows PRE OPERATE and RECIRCULATION, press the STANDBY/OPERATE Keypad Button for about 2 seconds. This will place the Milli-Q into STANDBY Mode. Then press the STANDBY/OPERATE Keypad Button again. The Milli-Q will now be in PRE OPERATE Mode. Press the MENU Keypad Button again for 2 seconds to enter the Customer Service Software.

➔

INSTALLATION

- Press the MENU Keypad Button 5 times (6 times for a Milli-Q Gradient A10). Stop when you see the LANGUAGE (under SERVICE OPTIONS) display.

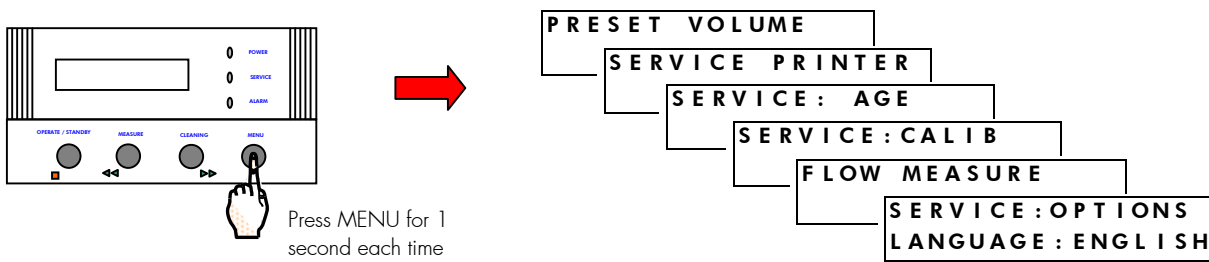

- Press the OPERATE/STANDBY Keypad twice (2 times). The RES. COMP choice will be shown.

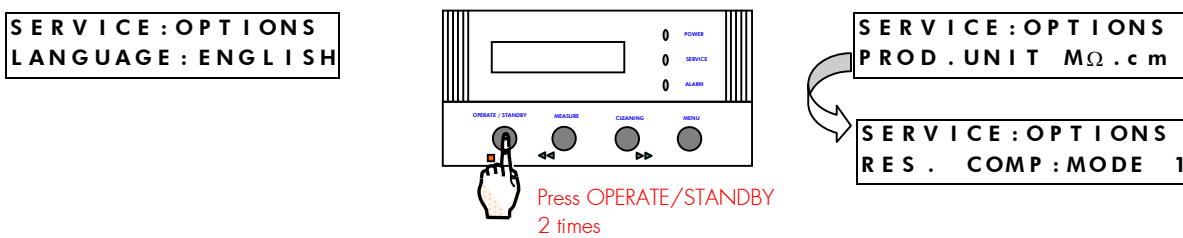

- Press the CLEANING Keypad Button twice to change from MODE 1 to OFF. The Resistivity Temperature Compensation will now be off.

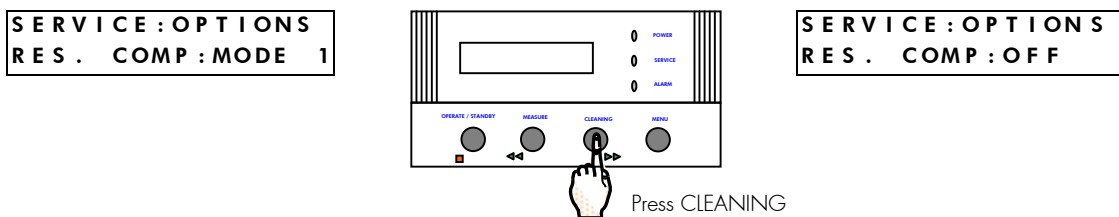

- Press the MENU Keypad Button for about 2 seconds to return to PRE OPERATE Mode.

SERVICE : O P T I O N S
R E S . C O M P : O F F

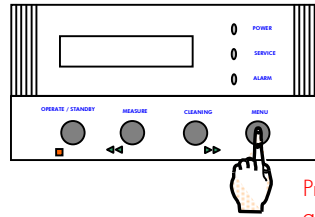

P R E O P E R A T E

Press MENU for
about 2 seconds

When the Milli-Q is in PRODUCT Mode (POU Dispenser Trigger forward), the Display will look like

P R E O P E R A T E

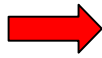

3 1 . 8 M Ω . c m 1 5 ° C

*Note that '@ 25°C' is missing in
a non temperature compensated
display mode.*

You have finished changing to non temperature compensated Resistivity or non temperature compensated Conductivity displays.

4-15 HOW TO SET THE DATE AND THE TIME OF DAY

The date (day-month-year) can be printed out or downloaded to a computer along with other operating data pertinent to the Milli-Q. The date is changed at midnight of each day. The time of day is not printed out or downloaded to a computer; it is used only to advance the date.

Follow the steps below to change the Date or the Time Of Day.

- Press the MENU Keypad button for about 2 seconds. The LCD will change as shown here:

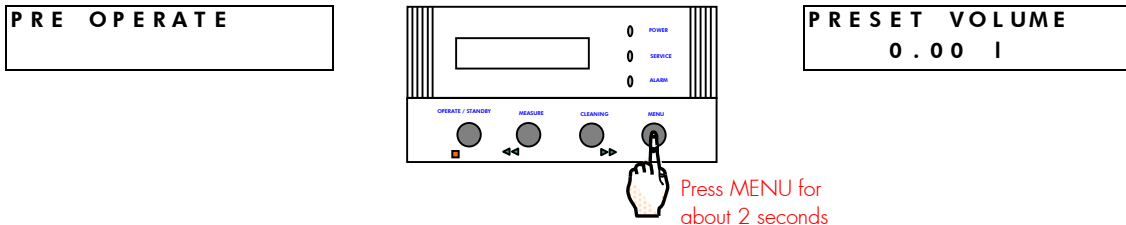

- You have entered the 'Customer Service Software' of the Milli-Q.

If you do not see this display, then turn off, then on the system power. When the LCD shows PRE OPERATE and RECIRCULATION, press the STANDBY/OPERATE Keypad Button for about 2 seconds. This will place the Milli-Q into STANDBY Mode. Then press the STANDBY/OPERATE Keypad Button again. The Milli-Q will now be in PRE OPERATE Mode. Press the MENU Keypad Button again for 2 seconds to enter the Customer Service Software.

- Press the MENU Keypad Button 6 times (7 times for a Milli-Q Gradient A10). Stop when you see the CALENDAR display.

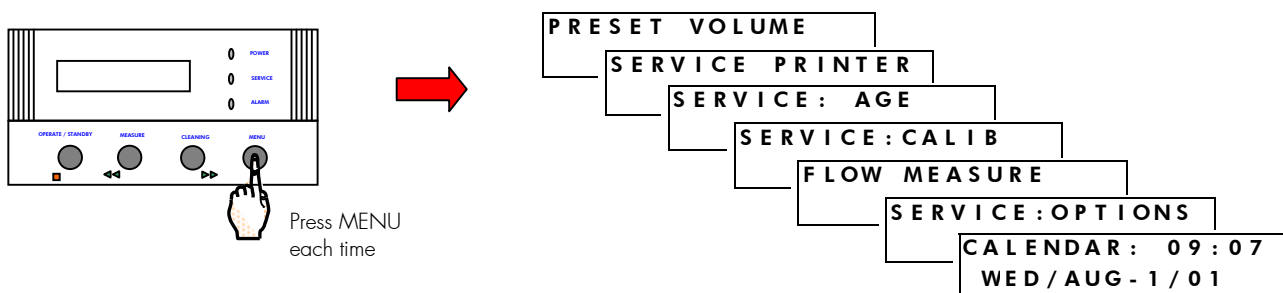

The Hour will be flashing.

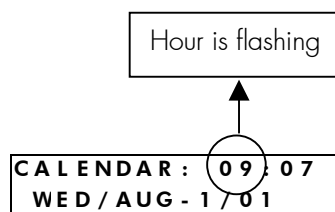

- Change the Hour by using the MEASURE or CLEANING Keypad Buttons.

CALENDAR: 09:07
WED/AUG-1/01

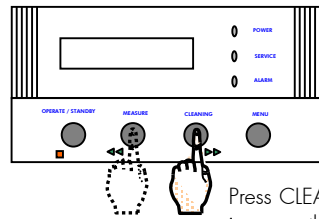

CALENDAR: 10:07
WED/AUG-1/01

Press CLEANING to increase the Hour

- Press the OPERATE Keypad Button to validate (select) the Hour. The Minutes will now be flashing.

CALENDAR: 10:07
WED/AUG-1/01

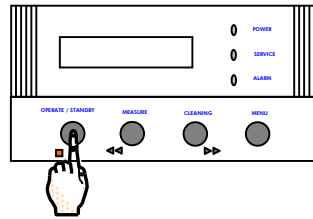

CALENDAR: 10:07
WED/AUG-1/01

Minutes flashing

- Repeat the two steps above to change the Day-Of-Week, the Month, the Day and the Year.
- When you are finished, press MENU for more than 2 seconds to go back to PRE OPERATE Mode.

CALENDAR: 10:07
WED/AUG-1/01

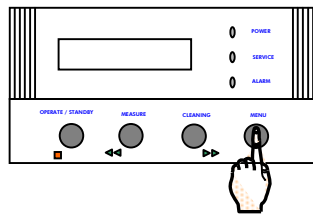

PRE OPERATE

You have finished setting the Date and the Time Of Day.

Chapter 5 USING THE MILLI-Q

5-1 HOW TO GET WATER FROM THE MILLI-Q

These instructions are written for the Milli-Q user who already has completed all of the installation steps in Chapter 4.

1. **Make sure the Milli-Q is in PRE OPERATE Mode.** If the Milli-Q is in STANDBY Mode, then press the OPERATE/STANDBY Keypad Button for about 2 seconds. This will change the Milli-Q from STANDBY Mode to PRE OPERATE Mode. See the drawing below for more information.

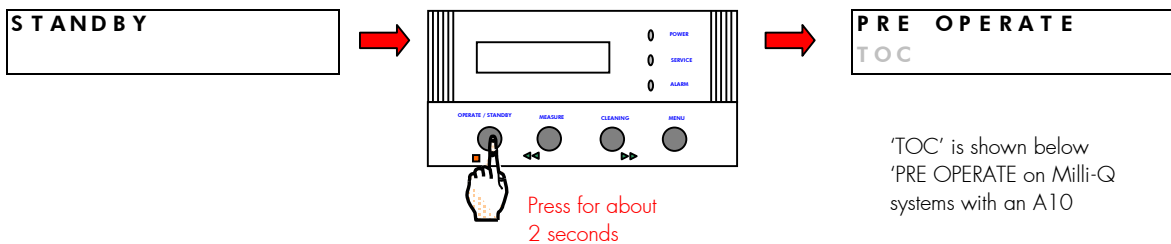

2. **Move the POU Dispenser Trigger forward and then back up.** This will place the Milli-Q in PRODUCT Mode but water will not be dispensed at the moment. A very small amount of water (i.e. 5 ml) may be dispensed out.
3. It is recommended to dispense about 150 to 200 ml of Product Water to the drain (or into a sink) every morning. After this, use the Milli-Q Product Water for your specific application.

NOTE: If you are using the Milli-Q frequently (i.e. a few times an hour), then you will not have to dispense 150 to 200 ml of Product Water to the drain.

4. **When the green LED stops blinking, move the POU Dispenser Trigger forward to dispense water.** It will stop blinking when the Product Water Resistivity (compensated to 25 °C) is greater than the Resistivity Setpoint and less than the TOC Setpoint (A10 system only). Normally, the Resistivity Setpoint is 16.0 MΩ.cm. It is recommended, but not necessary, to wait until the green LED stops blinking on the POU Dispenser.
5. **The Milli-Q will dispense water continuously for 30 minutes.** After 30 continuous minutes, the Milli-Q will stop dispensing water and will go into STANDBY Mode. Contact Millipore if you need to dispense water for more than 30 continuous minutes.
6. **When you are finished dispensing water, move the POU Dispenser Trigger back to the upright position.** The Milli-Q will continue to operate (but will not dispense water) for 90 seconds. After 90 seconds, the Milli-Q will automatically go to PRE OPERATE Mode.
7. **Leave the Milli-Q in PRE OPERATE Mode.** Do not leave it in STANDBY Mode unless you are going to perform some sort of maintenance (i.e. changing the Q-Gard and Quantum).

POU DISPENSER IN PRE-OPERATE MODE POSITION



POU DISPENSER IN PRODUCT MODE POSITION



5-2 STANDBY, PRE OPERATE AND PRODUCT MODE

WHAT IS STANDBY MODE?

STANDBY Mode is selected before attempting maintenance on the system. For example, you would select STANDBY Mode before removing the Q-Gard Pack. The Inlet Solenoid Valve is closed in STANDBY Mode.

The Milli-Q will not have an hourly 5 minute recirculation of water in STANDBY Mode. A Milli-Q Gradient A10 will not perform a TOC Analysis during STANDBY Mode.

In STANDBY Mode, you can move the POU Dispenser Trigger forward and then close it. This will open the POU Dispenser Electric Valve for 10 seconds. This will allow the system to depressurise. An example of when this would be needed is when you are about to remove a Q-Gard Pack.

WHAT IS PRE OPERATE MODE?

PRE OPERATE Mode is selected when the system is not dispensing water. For example, the Milli-Q would be left in PRE OPERATE Mode during the evenings and weekends and during other periods of non use. The Inlet Solenoid Valve is closed during PRE OPERATE Mode.

The Milli-Q will have an hourly 5 minute recirculation of water in PRE OPERATE Mode. This will enhance the quality of the Product Water delivered from the Milli-Q. A Milli-Q Gradient A10 will perform a single TOC analysis immediately following the hourly 5 minute recirculation of water. The Inlet Solenoid Valve is open during RECIRCULATION Mode.

WHAT IS PRODUCT MODE?

PRODUCT Mode is selected when you want to dispense water or when you want to get ready to dispense water from the Milli-Q. PRODUCT Mode is when you can see the resistivity and temperature of the Milli-Q product water. This is when you would see the TOC values with Milli-Q Gradient A10 systems.

PRODUCT Mode occurs because the POU Dispenser Trigger was moved forward. The Inlet Solenoid Valve is open in PRODUCT Mode.

The Milli-Q will dispense for a maximum of 30 continuous minutes in PRODUCT Mode. Contact Millipore if you need to dispense for more than 30 continuous minutes.

5-3 HOW TO VIEW THE RESISTIVITY, TEMPERATURE AND TOC

VIEWING RESISTIVITY

The Resistivity ($M\Omega.cm @ 25^\circ C$) of the Milli-Q Product Water is seen while the Milli-Q is in PRODUCT Mode.

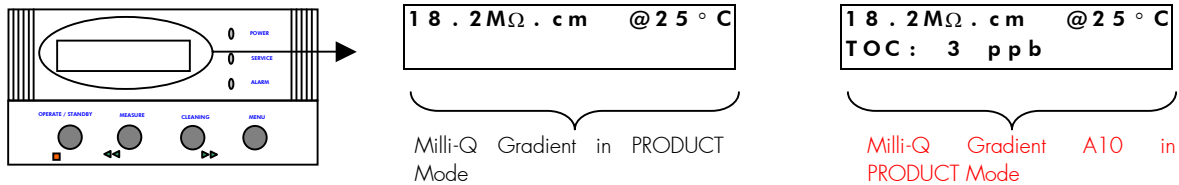

VIEWING TEMPERATURE

Press the MEASURE Keypad Button while the Milli-Q is in PRODUCT Mode.

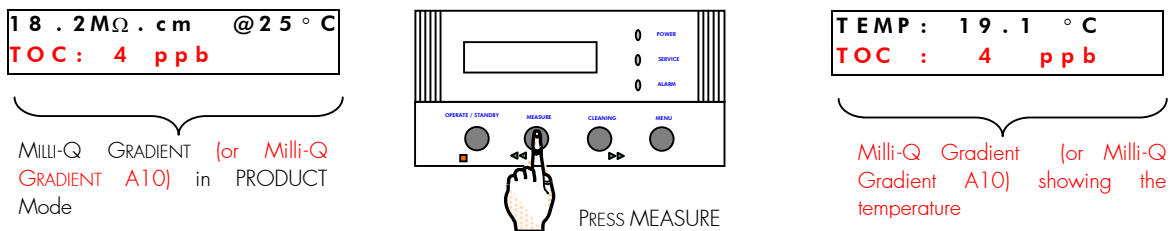

The temperature will be displayed for about 10 seconds. The LCD will return to the resistivity display.

VIEWING TOC

The TOC is only displayed if you have a Milli-Q Gradient A10 system.

The TOC of the Milli-Q Product Water is measured about every 5 minutes. When you go from PRE OPERATE Mode to PRODUCT Mode, a TOC Analysis is started.

The displayed TOC will not change until the next TOC Analysis is completed.

The TOC measurements will be repeated continuously during PRODUCT Mode.

The range of TOC values is from 1 ppb to 999 ppb in 1 ppb increments. A display of xxx ppb means that the TOC value measured is out of range.

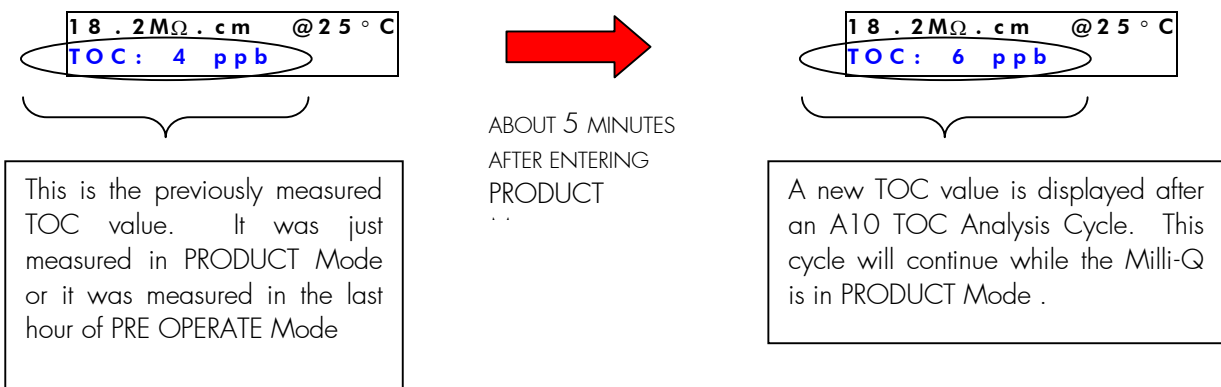

5-4 HOW TO USE THE FOOTSWITCH (OPTIONAL ACCESSORY)

The Footswitch is an optional accessory for the Milli-Q system. The instructions for installing the Footswitch are inside the shipping box of the Footswitch and are not in this manual.

The Footswitch can be installed so that you can have either:

- 'Hands Free' operation of the POU Dispenser that comes with the Milli-Q system.

- 'Hands Free' operation of a Remote POU Dispenser (another accessory).

It is not possible to have one Footswitch controlling 2 different POU Dispensers.

It is not possible to have two different Footswitches on a single Milli-Q System.

The Milli-Q will go from PRE OPERATE Mode to PRODUCT Mode when the Footswitch is depressed.

The Milli-Q will remain in PRODUCT as long as the Footswitch is depressed. When the Footswitch is released, the Milli-Q will go back to PRE OPERATE Mode after 90 seconds.

5-5 HOW TO DISPENSE AN EXACT AMOUNT OF PRODUCT WATER

It is possible to dispense pre-set volumes of water from the Milli-Q (0.25 Litre to 63.75 Litre in 0.25 Litre increments). The accuracy of this is dependent upon the accuracy of the Flow Calibration performed in Section 4-11.

- ❑ Make sure the Milli-Q POU Dispenser Flowrate is calibrated.
- ❑ Make sure the Millipak or BioPak is vented of air.
- ❑ Make sure the Quantum Cartridge is vented of air.
- ❑ Make sure you are in PRE OPERATE Mode.
- ❑ Move the POU Dispenser Trigger forward and then back up. This will place the Milli-Q into PRODUCT Mode but water will not be dispensed at the moment. A very small amount of water (i.e. 5 ml) may be dispensed out.
- ❑ The green LED on the side of the POU Dispenser will begin to blink. It will stop blinking when the Product Water Resistivity (compensated to 25 °C) is greater than the Resistivity Setpoint and less than the TOC Setpoint (A10 system only). Normally, the Resistivity Setpoint is 16.0 MΩ.cm. It is recommended, but not necessary, to wait until the green LED stops blinking on the POU Dispenser.
- ❑ Press MENU for about 2 seconds. The LCD should change as shown below.

PRE OPERATE

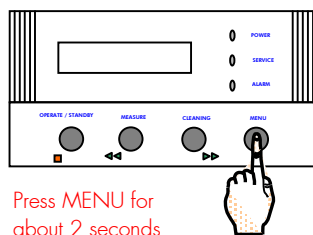

Press MENU for about 2 seconds

PRESET VOLUME
0.25 l

- ❑ Use the Keypad Arrow Keys (MEASURE or CLEANING) to set the volume of water you want to dispense from the Milli-Q.

18.2 MΩ . cm @ 25 ° C
TOC: 4 ppb

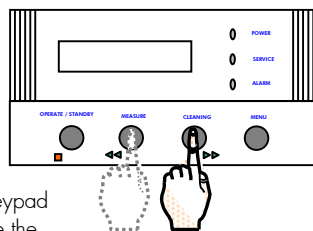

Use the Arrow Keypad Buttons to change the PRE-SET VOLUME value

PRESET VOLUME
6.50 l

6.50 L is the desired volume to be dispensed.

USING THE MILLI-Q

- ❑ Press the OPERATE/STANDBY Keypad Button to 'validate' your volume selection. The Milli-Q will now go to PRE OPERATE Mode.

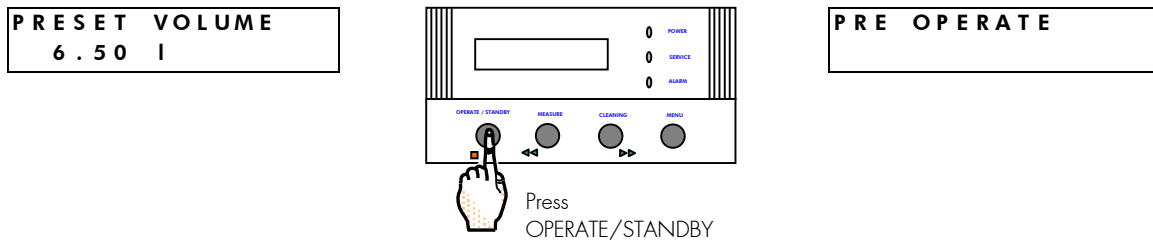

- ❑ Move the POU Dispenser Trigger forward. The Milli-Q will go from PRE OPERATE Mode to PRODUCT Mode. The LCD will show (lower right corner) the amount of water being dispensed.

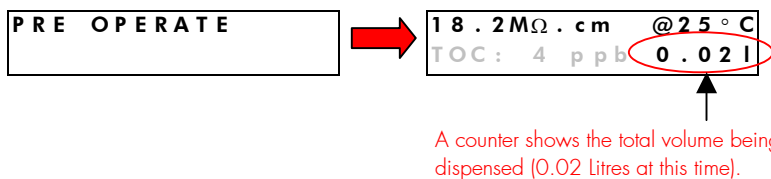

- ❑ Allow the water to be dispensed.
- ❑ **You can cancel the dispensing of water by moving the POU Dispenser Trigger upright (back to the PRE OPERATE position).**
- ❑ When the pre-set total volume of water has been dispensed from the Milli-Q, the system will automatically go to STANDBY Mode. The LCD will prompt you to 'CLOSE THE VALVE'.
- ❑ Bring the POU Dispenser Trigger to the upright position.
- ❑ The Milli-Q will now be in PRE OPERATE Mode.



If you want to automatically dispense the same volume of water again, then follow all of the steps above. You will not need to change the selected volume. It will remain the same from the prior selection.

5-6 HOW TO VIEW THE AGE OF THE CONSUMABLES

The Milli-Q Gradient has 4 consumable items. These include the Q-Gard Pack, the Quantum Cartridge, the Millipak (or BioPak) and the UV Lamp.

The Milli-Q Gradient A10 has 5 consumable items. These include the A10 UV Lamp, the Q-Gard Pack, the Quantum Cartridge, the Millipak (or BioPak) and the UV Lamp.

The age of these consumables can be viewed (except for the age of the BioPak). The age of a consumable is the number of calendar days that have passed since the consumable was installed. The age is displayed as a number of days. The number of days will increase by 1 every 24 hours.

The maximum recommended age of the Q-Gard, Quantum and Millipak is 180 days. The maximum recommended age of the A10 UV Lamp is 365 days.

A BioPak is replaced every 90 Days. A timer for this does not exist with the Milli-Q.

The maximum recommended age of the UV Lamp is 365 Days (1 year).

Follow the steps below to view the age of the consumable items.

- Press the MENU Keypad button for about 2 seconds. The LCD will change as shown here:

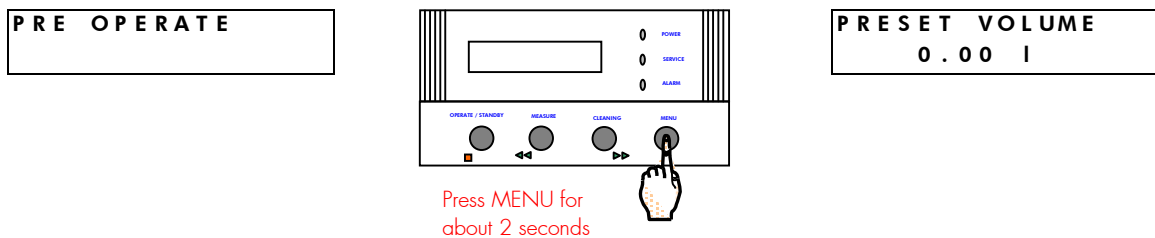

- You have entered the 'Customer Service Software' of the Milli-Q.

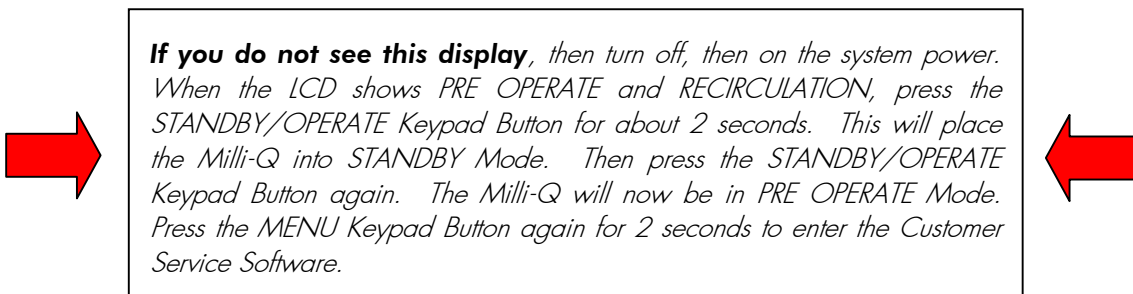

- Press the MENU Keypad Button 2 times.

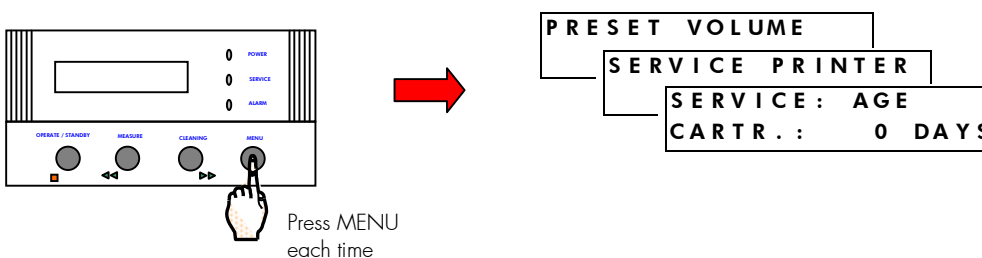

- ❑ Stop when you see the AGE display.
- ❑ In the example above, the AGE of the Cartridges (CART.) is 0 Days (installed in the last 24 hours). This is referring to both the Q-Gard and the Quantum. It is being assumed that the Millipak was changed when the Q-Gard and Quantum were changed.
- ❑ Press the OPERATE/STANDBY Keypad Button once to change to the age of the UV Lamp.

The AGE of the UV Lamp is 0 Days in the display below.

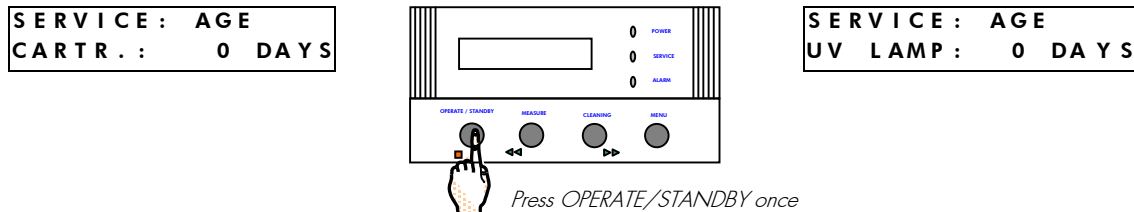

- ❑ **Milli-Q Gradient A10 only:** Press the OPERATE/STANDBY Keypad Button once to change to the age of the A10 UV Lamp.

The AGE of the A10 UV (the small UV Lamp on the A10 device) is 0 Days in the display below.

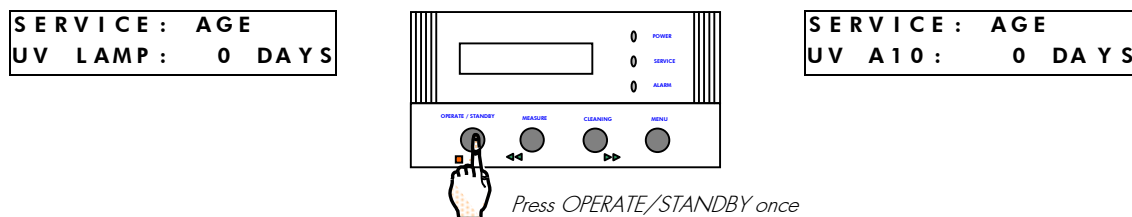

- ❑ Escape the Customer Service Software by pressing the MENU Keypad Button for about 2 seconds. You should be back to PRE OPERATE Mode.

You have finished viewing the age of the consumable items.

5-7 HOW TO UNDERSTAND MILLI-Q MESSAGES

It is possible for various messages to be displayed on the Milli-Q LCD while you are using the Milli-Q. While a message is being displayed, either the Yellow Service LED or the Red Alarm LED can be blinking.

The table below provides a summary of these messages, what they mean and what to do when you see them. **You may also refer to Chapter 7 (Troubleshooting) for more information about these messages and other troubleshooting items.**

Please contact Millipore if you desire more information regarding what to do when a message appears on the Milli-Q.

Message and System Status	What it means	What to do
EXCH. CARTRIDGES	Milli-Q Gradient: The Q-Gard and Quantum have been installed for more than 180 Calendar Days or the Resistivity is below the Resistivity Setpoint (Factory Value is 16.0 MΩ.cm @ 25°C).	Replace the Q-Gard and the Quantum (and the Millipak or BioPak).
EXCH. CARTRIDGES	Milli-Q Gradient A10: The Resistivity is below the Resistivity Setpoint (Factory Value is 16.0 MΩ.cm @ 25°C).	Replace the Q-Gard and the Quantum (and the Millipak or BioPak).
TOC > SETPOINT	The displayed TOC (Milli-Q Gradient A10 only) is greater than the TOC Setpoint established in the software.	A TOC value above the TOC Setpoint can have many causes. Contact Millipore.
CARTRIDGE OUT The Milli-Q will not operate. This message must be resolved before the Milli-Q can operate.	Either the Q-Gard Pack or the Quantum Cartridge is not installed correctly or one of them is absent.	Reinstall either or both the Q-Gard Pack or the Quantum Cartridge.
NO FEED WATER The Milli-Q will not operate. This message must be resolved before the Milli-Q can operate.	An optional accessory has detected that there is no feedwater going to the Milli-Q. This accessory is not factory installed and needs to be installed in the system.	Make sure the Reservoir or the Pressurised Pipe feeding the Milli-Q has a supply of feedwater that can be delivered to the Milli-Q.
REBOOT SYSTEM	Milli-Q Gradient A10 only: The A10 has tried for > 15 minutes to process a TOC value but was not successful.	Turn off the electrical power. Turn it on 20 to 30 seconds later. If the message appears again, then contact Millipore.

Message and System Status	What it means	What to do
EXCHANGE UV	The UV Lamp has been installed for 365 days.	Replace the UV Lamp.
EXCHANGE A10 UV	Milli-Q Gradient A10 only: The A10 has a small UV Lamp inside. It has been installed for 365 calendar days.	Replace the A10 UV Lamp.
SYSTEM ERROR 1	The Motor Voltage is too high (> 49 VDC).	Contact Millipore.
SYSTEM ERROR 2	The measured temperature is < 0°C.	Contact Millipore.
SYSTEM ERROR 3	The measured temperature is > 45°C.	Check the feedwater temperature – lower if necessary. Contact Millipore if the measured temperature is incorrect.
SYSTEM ERROR 4 The ionic levels in the Milli-Q Product Water are elevated and it is the decision of the Milli-Q user whether to use the water or not.	The measured resistivity value (@ 25°C) is between 3.5 and 2.5 MΩ.cm.	Contact Millipore for assistance.
SYSTEM ERROR 5	The measured resistivity is too high (> 65.5 MΩ.cm). The displayed resistivity may not show any higher than 18.2 MΩ.cm.	Dispense water from the Milli-Q to remove any air bubbles that could be trapped in the Resistivity Sensor Cell. Contact Millipore if the message continues.
SYSTEM ERROR 7 The POU Dispenser will not dispense water. You will not be able to dispense water.	The voltage being sent to the UV Ballast Power Supply on the Interface PC Board is < 5 VDC or > 39 VDC. This is also the Power Supply for the Solenoid Valve in the POU Dispenser.	Contact Millipore.
SYSTEM ERROR 8 The POU Dispenser will not dispense water. You will not be able to dispense water.	The electrical intensity being sent to the UV Ballast Power Supply on the Interface PC Board is < 5 mA or > 950 mA. This is also the Power Supply for the Solenoid Valve in the POU Dispenser.	Contact Millipore.

Message and System Status	What it means	What to do
SYSTEM ERROR 10	An error occurred with data transfer to or from the Milli-Q microprocessor (E ² Prom).	Turn off the Milli-Q. Turn it back on about 20 to 30 seconds later. If the message continues, then contact Millipore.
A10 ERROR 0	A10 PCB E ² Prom defective.	Turn off/on the Milli-Q and dispense water for > 6 minutes. If the message continues, then contact Millipore.
A10 ERROR 1	A10 PCB A/D converter defective.	Turn off/on the Milli-Q and dispense water for > 6 minutes. If the message continues, then contact Millipore.
A10 ERROR 2	A10 Thermistor defective.	Turn off/on the Milli-Q and dispense water for > 6 minutes. If the message continues, then contact Millipore.
A10 ERROR 3	Problem occurred with temperature compensation.	Turn off/on the Milli-Q and dispense water for > 6 minutes. If the message continues, then contact Millipore.
A10 ERROR 4	The water entering the A10 is < 4°C.	Contact Millipore.
A10 ERROR 5	The water entering the A10 is > 41°C.	Contact Millipore.
A10 ERROR 6	The conductivity of the water entering the A10 is > 1.1 μS/cm.	Contact Millipore.
A10 ERROR 7	The temperature inside the A10 during its analysis mode reached > 55°C.	Contact Millipore.
A10 ERROR 9	The TOC is very low or a problem occurred with the A10.	Contact Millipore.

Chapter 6 MAINTENANCE

6-1 MAINTENANCE SCHEDULE

See the Maintenance Guide below for the typical maintenance that needs to be performed on your Milli-Q Gradient or Milli-Q Gradient A10. The Catalogue Numbers and other ordering information can be found in Sections 8-1 and 8-2. Detailed information about the various consumable items can be found in Sections 2-2 and 2-3.

Item or action	Maintenance needed	When?	How to?
Q-Gard Pack	Replacement	When the system resistivity or TOC values are outside of specification or the EXCH. CARTRIDGE message is displayed.	See Section 6-2.
Quantum Cartridge	Replacement	Replace when the Q-Gard Pack is replaced.	See Section 6-3.
Millipak	Replacement	Replaced when the Quantum Cartridge and Q-Gard Pack are replaced or when the Product Water Flowrate drops.	See Section 6-4.
BioPak	Replacement	Every 90 Days.	See Section 6-5.
Screen Filter	Cleaning	2 times a year or as necessary.	See Section 6-6.
Flow Calibration	Perform a calibration	<ul style="list-style-type: none"> When the Millipak (or BioPak) is replaced. <hr/> <ul style="list-style-type: none"> Periodically. 	See Section 4-11.
POU Dispenser Arm	Tightening	As necessary.	See Section 6-7.
A10 UV	Replacement	Every 365 Days.	See Section 6-8.
A10 Cleaning	Perform a cleaning	<ul style="list-style-type: none"> Automatic when the Quantum is replaced. <hr/> <ul style="list-style-type: none"> As necessary. 	See Section 6-9.
UV Lamp	Replacement	Every 365 Days	See Section 6-10.

6-2 HOW TO REPLACE THE Q-GARD

The Q-Gard is normally replaced every 180 Days or when the Product Water quality is not optimal (i.e. drop in Resistivity, increase in TOC, ionic breakthrough,...).

For Milli-Q Gradient Systems: A Service Message, EXCH. CARTRIDGES, will be shown after 180 Calendar Days or when the Product Water Resistivity is less than the Resistivity Setpoint. This Setpoint is factory set to 16 MΩ.cm (@ 25°C).

For Milli-Q Gradient A10 Systems: A Service Message, EXCH. CARTRIDGES, will be shown when the Product Water Resistivity is less than the Resistivity Setpoint. This Setpoint is factory set to 16 MΩ.cm (@ 25°C).

When the Q-Gard is replaced, the 180-Day Age is reset to 0 Days. In addition, any Resistivity data measured below the Resistivity Setpoint is erased from the Milli-Q system's computer memory. These 2 items will remove the EXCH. CARTRIDGES message from the LCD.

Follow the steps below to replace the Q-Gard Pack.

Removing the used Q-Gard

- ❑ Place the Milli-Q into STANDBY Mode. See Section 5-1 for more information if necessary.
- ❑ While in STANDBY Mode, move the POU Dispenser Trigger forward. This will open the electric valve inside the POU Dispenser. Any residual water pressure will be released. Allow any water to flow from the POU Dispenser in STANDBY Mode. Move the POU Dispenser Trigger back to the upright position.
- ❑ Locate the Q-Gard on the front right side of the Milli-Q. Locate the Pack Adapter Lid at the top of the Q-Gard.
- ❑ Lift up the Pack Adapter Lid and remove the Metal Clip from the metal rod.
- ❑ Gently pull the Q-Gard from the metal rod.

Installing the new Q-Gard

- ❑ Remove the Q-Gard from its shipping box. Verify the Millipore Catalogue Number by looking at the sticker on top of the Q-Gard. Remove the plastic covers on the 2 ports of the Q-Gard Pack. Look inside the ports to locate the black rubber O-rings. Make sure these are pushed in so they are firmly in-place.
- ❑ Wet the Q-Gard O-rings with water. It is preferable to wet them with Ultrapure Water. **DO NOT WET THE O-RINGS WITH A LUBRICANT SUCH AS OIL OR SILICON GREASE.**
- ❑ Locate the small protruding piece of plastic near the bottom of the Q-Gard. Push this into the small hole in the Milli-Q Cabinet. This will aid in holding the Q-Gard Pack upright.
- ❑ Push the Q-Gard Pack onto the Pack Adapter. The Q-Gard rubber O-rings will be making a water tight seal. It is important that the Q-Gard is pushed in fully. **The notch on the end of the metal rod on the Pack Adapter should come through the hole on the Q-Gard Pack.**
- ❑ Locate the Metal Clip that is attached to the Pack Adapter with a piece of filament wire. Push the Metal Clip onto the notch of the Metal Rod (see the step above). The top of the Metal Clip should bend towards you. This will allow you to easily remove it when the Q-Gard is replaced later.

The Q-Gard is now installed.



Since the Quantum Cartridge is replaced whenever a Q-Gard Pack is replaced, proceed to Section 6-3 'How to replace the Quantum Cartridge'.

INSTALLATION OF THE Q-GARD PACK

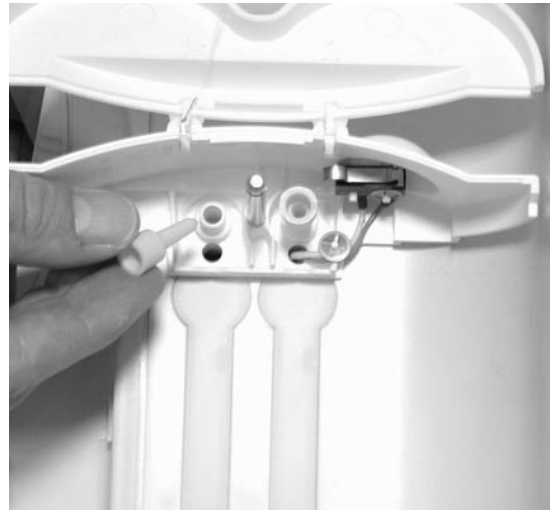

6-3 HOW TO REPLACE THE QUANTUM CARTRIDGE

The Quantum Cartridge is replaced whenever the Q-Gard Pack is replaced. This is important for maintaining optimum water quality.

Follow the steps below to replace the Quantum Cartridge.

Removing the Quantum Cartridge from the Milli-Q

- ❑ Make sure the Milli-Q is in STANDBY Mode. See Section 5-1 for more information if necessary.
- ❑ Since the Q-Gard was just replaced (see Section 6-2), it is not necessary to release the residual water pressure in STANDBY Mode.
- ❑ Open the top and bottom latches of the door on the front of the Milli-Q system cabinet. Fully open the door.
- ❑ Remove the Quantum Cartridge from the Milli-Q.

Installing a new Quantum Cartridge

- ❑ Remove the Quantum Cartridge from its shipping box. Confirm that you have the desired type of Quantum Cartridge by viewing the label on the Quantum Cartridge.
- ❑ Remove the 2 plastic covers on the ports of the Quantum Cartridge. There should be a black rubber O-ring in each port. Make sure these are pushed firmly in place.
- ❑ Wet the Quantum Cartridge O-rings with water. It is preferable to wet them with Ultrapure Water. **DO NOT WET THE O-RINGS WITH A LUBRICANT SUCH AS OIL OR SILICON GREASE.**
- ❑ Push the Quantum Cartridge firmly into place. Both the top and bottom ports of the Quantum Cartridge have to be fully seated.
- ❑ Close the door.



Make sure that both the top latch and the bottom latch of the door are fully closed. Each latch should 'click' when it is fully closed.

The Quantum Cartridge is now installed.



You now need to perform an AIR PURGE with the Milli-Q system in order to remove all air from the newly installed Q-Gard and Quantum.

- ❑ Remove the used Millipak from the POU Dispenser.
- ❑ Locate the clear Tygon Tubing and the Barbed Fitting from the Accessories Bag.
- ❑ Screw the Barbed Fitting onto the bottom end of the POU Dispenser.



Do not use any Teflon Tape on the threads of the Barbed Fitting. An O-ring is located inside the POU Dispenser to insure water tightness between the threads of the POU Dispenser and the Barbed Fitting.

- ❑ Push one end of the Tygon Tubing onto the end of the Barbed Fitting. Place the other end of the Tygon Tubing into a sink.
- ❑ At this time you should have installed the Q-Gard Pack, Quantum Cartridge, Barbed Fitting and the Tygon Tubing. The system power should be on. The POU Dispenser Trigger should be upright. The LCD should be showing STANDBY.

- ❑ **Put the Milli-Q into PRE OPERATE Mode.** Press the OPERATE/STANDBY Keypad Button for about 2 seconds. This will change the Milli-Q from STANDBY Mode to PRE OPERATE Mode. See the drawing below for more information.

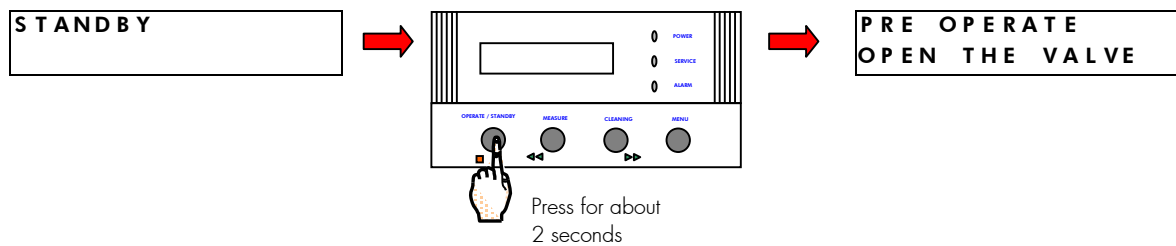

- ❑ **Move the POU Dispenser Trigger forward.** This will place the Milli-Q into PRODUCT Mode.
- ❑ Verify that you have several Litres (> 1.5 Litres) of feedwater (i.e. full Reservoir or full Distribution Loop).
- ❑ Bring the POU Dispenser Trigger down (towards you). You should hear a sharp 'click' noise. This is the opening of the Inlet Solenoid Valve.
- ❑ The LCD will change and will look like:



- ❑ Let the AIR PURGE continue for its 5 minute duration. It will count down to 0 minutes (5, 4, ..., 0 mn).
- ❑ **Pressurised Feedwater Only:** *Check the Pressure Gauge on the Pressure Regulator. While water is flowing through it, the Pressure Gauge should show 0.3 bar. If it is not set to 0.3 bar, then turn the round handle on the Pressure Regulator clockwise until the pressure gauge (on the regulator) shows 0.3 bar. Check this again when water is flowing through the Pressure Regulator.*



The setting of the Pressure Regulator should not exceed 0.3 bar. The feedwater pressure reaching the Milli-Q in PRODUCT Mode should not exceed 0.3 bar. The Pressure Regulator should only be set while water is flowing through it. It is perfectly normal to see an increase in the Pressure Regulator setting while water is not flowing through it (i.e. STANDBY or PRE OPERATE Mode).

- ❑ The Milli-Q will now go to STANDBY Mode and will remind you to close the POU Dispenser Valve.
- ❑ Move the POU Dispenser Trigger back (its upright position). The Milli-Q will now go to PRE OPERATE Mode.

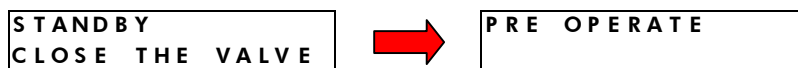

- ❑ **Milli-Q Gradient A10 only:** *When you 'Close The Valve', the Milli-Q will go to PRE OPERATE Mode and then will start an automatic 60 minute A10 CLEANING. The A10 CLEANING is a way of flushing out any particles from the A10 that may have been present.*



- ❑ **Milli-Q Gradient A10 only:** Allow the A10 CLEANING to count down to 0 minutes.

The remaining steps of this section apply to both the Milli-Q Gradient and the Milli-Q Gradient A10.

- ❑ Any remaining air in Quantum Cartridge can be 'hand purged' out now.
- ❑ Get a screwdriver with a very thin shaft and small head.
- ❑ Locate the small hole on the top part of the Quantum Cartridge Door.
- ❑ **Gently** insert the screwdriver into the Quantum Cartridge. This will open a small vent that will expel any air in the Quantum Cartridge.



Be very careful when pushing the tip of the screwdriver into the Vent Hole of the Quantum Cartridge. The Vent Hole only needs to be opened a very small amount.

- ❑ If all of the air does not expel out, do not worry. You can repeat this step later after more water has flowed through the Milli-Q. Remember to have the Milli-Q in STANDBY or PRE OPERATE Mode.

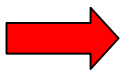

You now need to allow the Q-Gard Pack and the Quantum Cartridge to hydrate overnight. This helps to produce high quality Product Water.

- ❑ At this time, the Millipak is not installed. The Barbed Fitting and Tygon Tubing should still be attached to the end of the POU Dispenser.
- ❑ **Leave the Milli-Q in PRE OPERATE Mode overnight or for several hours.** This will aid in rinsing off the purification media inside the Q-Gard Pack and the Quantum Cartridge.
- ❑ (The next morning) Bring the POU Dispenser Trigger forward to put the Milli-Q into PRODUCT Mode.
- ❑ Allow about 10 to 15 Litres (7 to 10 minutes of PRODUCT Mode) of water to be dispensed from the Milli-Q.
- ❑ Bring the POU Dispenser Trigger upright. The Milli-Q will go into PRE OPERATE Mode after 90 seconds.
- ❑ **Leave the Milli-Q in PRE OPERATE Mode.**

The Q-Gard Pack and Quantum Cartridge are now fully air purged and hydrated.



If you are installing a Millipak, then proceed to Section 6-4.

If you are installing a BioPak, then proceed to Section 6-5.

INSTALLATION OF THE QUANTUM CARTRIDGE



MAINTENANCE

INSTALLATION OF BARBED FITTING AND TYGON TUBING

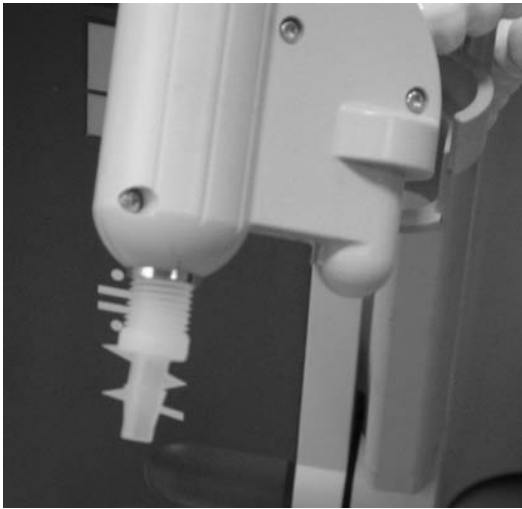

PURGING AIR FROM THE QUANTUM CARTRIDGE



INSTALLATION AND AIR PURGE OF THE MILLIPAK



6-4 HOW TO REPLACE THE MILLIPAK

The Millipak is normally replaced when the Q-Gard Pack and Quantum Cartridge are replaced. The Millipak may need to be replaced at an earlier time if it becomes clogged. A clogged Millipak will considerably reduce the Milli-Q Product Water flowrate.

Follow the steps below to replace the Millipak.

- ❑ Make sure the Q-Gard Pack and Quantum Cartridge have been air purged. Make sure they have been hydrated overnight.
- ❑ Remove the Barbed Fitting and Tygon Tubing from the POU Dispenser.
- ❑ Screw the Millipak onto the POU Dispenser. Turn it until it is handtight. **Do not overtighten the Millipak.**



Do not use Teflon Tape on the threads of the Millipak. The POU Dispenser has an O-ring inside which provides a watertight seal.

- ❑ Move the POU Dispenser Trigger forwards. This will bring the Milli-Q system into PRODUCT Mode.
- ❑ Locate the air vent valve on the top side (clear side) of the Millipak. Open this slowly but **do not remove the air vent from the Millipak**. Allow any air on the clear side of the Millipak to be vented out.
- ❑ Dispense about 5 Litres of water. Make sure all air is purged out.



Air will not pass through the membrane filter in the Millipak. If there is trapped air in the Millipak, then a reduction in Product Water flowrate can result.

- ❑ Move the POU Dispenser Trigger back to the upright position. The Milli-Q will go into PRE OPERATE Mode after 90 seconds. Leave the Milli-Q in PRE OPERATE Mode.



It is highly recommended not to put Tygon Tubing or any other type of tubing on the end of the Millipak. This can compromise the Product Water quality.

The Millipak is now installed and rinsed out.



At this time, it is highly recommended to recalibrate the Product Water flowrate from the Milli-Q. See Section 4-11 'How to calibrate ...' for more information.

Remember to leave the Milli-Q in PRE OPERATE Mode during times of non use (i.e. evenings, weekends, holidays, ...).

6-5 HOW TO REPLACE THE BIOPAK

Please refer to the Insert supplied with the BioPak.

6-6 HOW TO CLEAN THE SCREEN FILTER

The Screen Filter is located in the Assembly of blue fittings that came in the Accessories Bag (from the Shipping Box).

The purpose of the Screen Filter is to prevent a large particle or other debris from entering the Inlet Solenoid Valve of the Milli-Q System. This will allow the Inlet Solenoid Valve to open and close correctly. If the Screen Filter becomes blocked with debris ('clogged'), then feedwater will not flow freely to the Milli-Q.

It is recommended to clean the Screen Filter twice a year or whenever it may have become clogged. An example of this would be if there was a large amount of debris introduced into the feedwater supply (i.e. plumbing work done on the feedwater pipe).

Follow the instructions below for cleaning the Screen Filter.

- ❑ Make sure the Milli-Q is in PRE OPERATE Mode.
- ❑ Locate the Shut Off Valve on the feedwater supply. Turn off the valve.
- ❑ Bring the POU Dispenser Trigger forward for about 5 seconds. The Milli-Q will go into PRODUCT Mode. This will depressurise the Feedwater Tubing. Bring the POU Dispenser Trigger back.
- ❑ Place the Milli-Q into STANDBY Mode.
- ❑ Locate the Screen Filter. This will be located where the feedwater 8 mm OD tubing originates (i.e. where the 8 mm tubing meets a pressurised pipe).
- ❑ Unscrew the collar that holds the Feedwater Tubing to the barbed end of the fittings. Pull the tubing off of the fitting.
- ❑ Unscrew the Screen Filter from the Feedwater Pipe (Loop).
- ❑ Go to a sink and flush tap water backwards through the Screen Filter. The water would flow through the barbed end first. Any trapped debris on the Screen Filter would be flushed out.
- ❑ Stop flushing the Screen Filter. View inside to make sure it is now clear of debris.
- ❑ Locate the Roll of Teflon Tape from the Milli-Q Accessories Bag (from the Shipping Box).
- ❑ Apply 3-4 turns of new Teflon Tape to the threads of the Feedwater Pipe. Apply the tape in a clockwise direction.
- ❑ Screw the Screen Filter back onto the feedwater supply pipe.
- ❑ Attach the Feedwater Tubing back onto the Barbed Fitting. Make sure the tubing is securely fastened.
- ❑ Open the Feedwater Supply Valve.
- ❑ Place the Milli-Q into PRODUCT Mode to dispense some water from it. See Section 5-1 for more information on how to do this. During this time, check the setting of the Feedwater Pressure Regulator. It should be set to a value between 0.1 bar and 0.3 bar.
- ❑ Leave the Milli-Q in PRE OPERATE Mode when you are done dispensing water.

You have finished cleaning the Screen Filter.

SCREEN FILTER CLEANING



TIGHTENING OF THE POU DISPENSER ARM

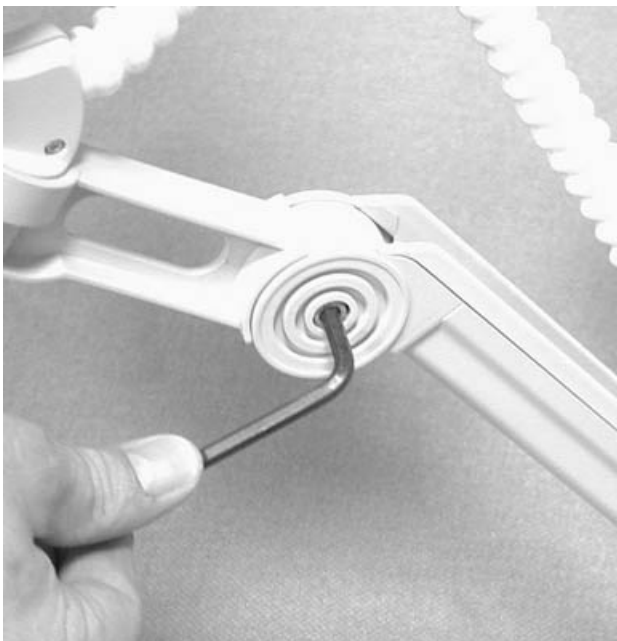

6-7 HOW TO TIGHTEN THE POU DISPENSER ARM

The POU Dispenser Arm is moved up and down during the times that water is dispensed from the Milli-Q System.

Follow these instructions to tighten the POU Dispenser Arm

- Locate the 'Allen' Wrench (6-sided black wrench) from the accessories bag (from the Shipping Box).
- Locate the 2 bolts that hold the various pieces of the Dispenser Arm in place.
- Tighten these bolts until the arm is secure.

You have finished tightening the POU Dispenser Arm.

6-8 HOW TO REPLACE THE A10 UV LAMP

The A10 UV Lamp is normally replaced once a year (every 365 Days).

A message, EXCHANGE A10 UV, will appear after 365 Calendar Days indicating that the A10 UV Lamp needs to be replaced.

It is recommended to have a Millipore Field Service Representative change the A10 UV Lamp. The replacement of the A10 UV Lamp involves removing the cover of the system. The instructions for replacing the A10 UV Lamp are not included in this manual. The instructions are included with the replacement A10 UV Lamp.

Contact Millipore for a copy of these instructions if you would like to see them before ordering a replacement A10 UV Lamp.

6-9 HOW TO CLEAN THE A10 TOC MONITORING DEVICE

The A10 TOC Monitoring Device may need to be cleaned sometimes. This cleaning does not involve any chemical reagents. This cleaning is initiated with the Milli-Q software and is simple to perform.

HOW LONG DOES THE A10 CLEANING TAKE?

The A10 Cleaning takes 60 minutes to complete. The LCD will show a countdown timer indicating the remaining time until the A10 Cleaning is finished.

WHY WOULD I NEED TO DO AN A10 CLEANING?

The A10 Cleaning is recommended when:

1. the Q-Gard and Quantum have been replaced (see the next question below).
2. the displayed TOC values are fluctuating.
3. the displayed TOC values are higher than normally seen.
4. the Milli-Q has been in STANDBY Mode or powered off for more than 12 hours.

WOULD AN A10 CLEANING EVER HAPPEN AUTOMATICALLY?

An A10 Cleaning will occur automatically after the Q-Gard Pack and Quantum Cartridge are exchanged. Normally, a 5 minute AIR PURGE Mode is started after the Quantum Cartridge is replaced. When the AIR PURGE is finished, the 60 minute A10 CLEANING Mode is started.

See Section 4-7 for more information about the AIR PURGE and the automatic A10 CLEANING Mode.

HOW DO I DO AN A10 CLEANING?

Follow these steps below to perform an A10 CLEANING

- ❑ If the Milli-Q is in STANDBY Mode, then press the OPERATE/STANDBY Keypad Button for about 2 seconds. This will change the Milli-Q from STANDBY Mode to PRE OPERATE Mode. See the drawing below for more information.

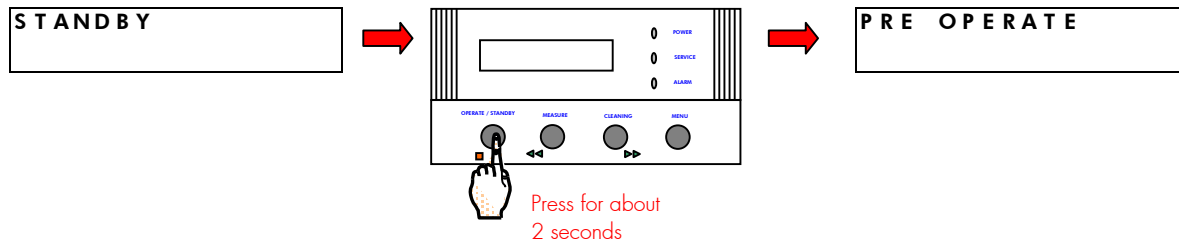

- ❑ Press the MENU Keypad button for about 2 seconds. The LCD will change as shown here:

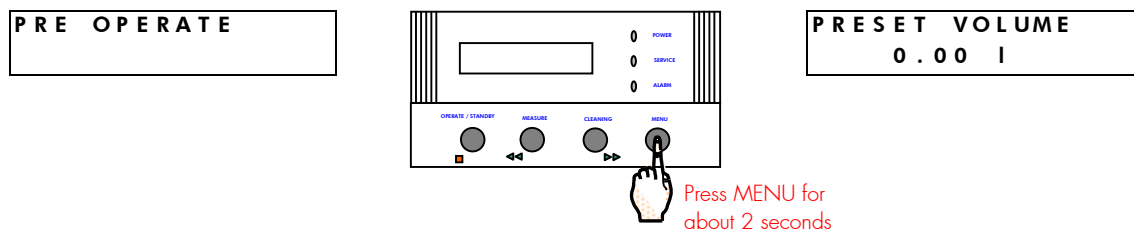

- ❑ You have entered the 'Customer Service Software' of the Milli-Q.

➔

If you do not see this display, then turn off, then on the system power. When the LCD shows PRE OPERATE and RECIRCULATION, press the STANDBY/OPERATE Keypad Button for about 2 seconds. This will place the Milli-Q into STANDBY Mode. Then press the STANDBY/OPERATE Keypad Button again. The Milli-Q will now be in PRE OPERATE Mode. Press the MENU Keypad Button again for 2 seconds to enter the Customer Service Software.
➔

- ❑ Press the MENU Keypad Button 5 times. Stop when you see the SERVICE: A10 A10 CLEANING display.

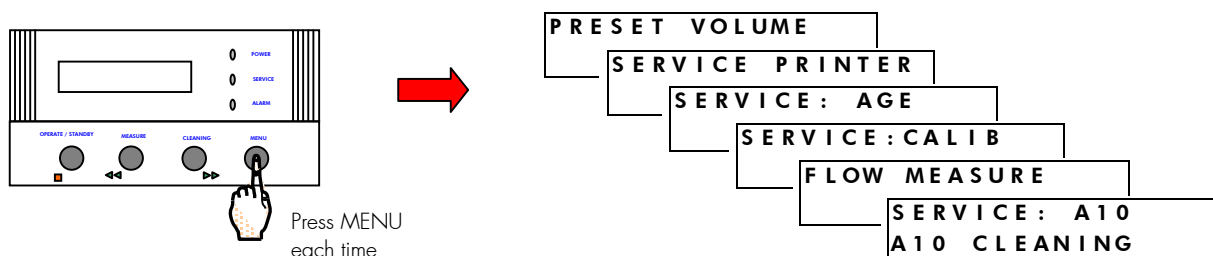

- ❑ **WAIT. Do not press the Keypad.** The A10 CLEANING Mode will start automatically after 5 seconds. The 60 minute timer will be shown.



- ❑ Wait for the A10 CLEANING Mode to finish.
- ❑ The Milli-Q will automatically go to PRE OPERATE Mode at the end of the A10 CLEANING Mode.

You are now finished performing an A10 CLEANING.

HOW DO I CANCEL THE A10 CLEANING ONCE IT IS STARTED?

Press the MENU Keypad Button for about 2 seconds during the A10 CLEANING Mode to cancel it. The Milli-Q will return to PRE OPERATE Mode.

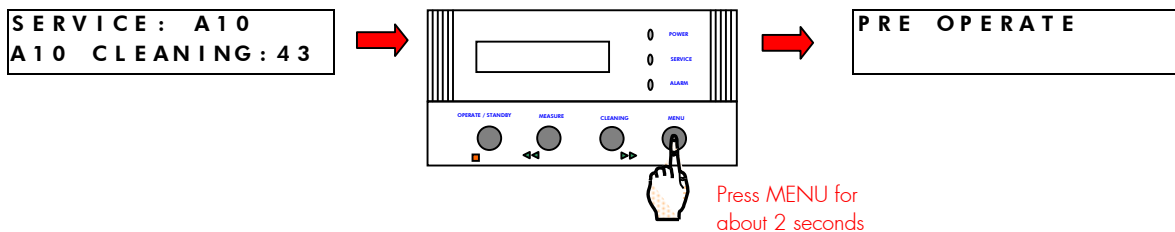

6-10 HOW TO REPLACE THE UV LAMP

The UV Lamp is normally replaced once a year (every 365 Days).

A message, EXCHANGE UV, will appear after 365 Calendar Days indicating that the UV Lamp needs to be replaced.

It is recommended to have a Millipore Field Service Representative change the UV Lamp. The replacement of the UV Lamp involves removing the cover of the system. The instructions for replacing the UV Lamp are not included in this manual. The instructions are included with the replacement UV Lamp.

Contact Millipore for a copy of these instructions if you would like to see them before ordering a replacement UV Lamp.

Chapter 7 TROUBLESHOOTING

THE PROBLEM IS LOW OR NO FLOWRATE FROM THE POU DISPENSER

CAUSE	REMEDY
System is in PRE OPERATE Mode.	Place Milli-Q into PRODUCT Mode. See Section 5-1.
No feedwater to the Milli-Q from the Reservoir. Remove the Feedwater Tubing from the Milli-Q. Confirm that there is water coming to the Milli-Q.	<ul style="list-style-type: none"> • Reservoir is empty. • Fitting on bottom of Reservoir is too tight; gasket on fitting is flattened and restricts water flow. • Reservoir is located lower than the Milli-Q. • Kink in Feedwater Tubing. • Valve on bottom of Reservoir is closed by mistake.
No feedwater to the Milli-Q from Pressurised Pipe (Loop). Remove the Feedwater Tubing from the Milli-Q. Confirm there is water coming to the Milli-Q.	<ul style="list-style-type: none"> • No water in Loop. • Water is not pressurised in Loop. • Pressure Regulator on Feedwater Tubing is not adjusted to between 0.1 and 0.3 bar while water is flowing through it (Milli-Q in PRODUCT Mode). See Section 4-7. • Pressure Regulator is installed backwards. See Section 4-1.
Millipak is airlocked.	<ul style="list-style-type: none"> • Vent air out while system is in PRODUCT Mode. See Section 4-9.
Millipak is clogged and will not allow water through it.	<ul style="list-style-type: none"> • Measure water flow with and without Millipak installed. Change Millipak and vent air out. See Section 4-9.
BioPak is clogged.	<ul style="list-style-type: none"> • Use a new BioPak.
Screen Filter is clogged.	<ul style="list-style-type: none"> • Clean the Screen Filter. See Section 6-6.
Problem with internal component (motor not operating; Inlet Solenoid Valve not opening).	<ul style="list-style-type: none"> • Contact Millipore.
Remote POU Dispenser connected wrong or not plugged into the Milli-Q.	<ul style="list-style-type: none"> • Check tubing connections on back of Milli-Q. See instructions that came with Remote POU Dispenser.

THE PROBLEM IS LOW RESISTIVITY OF THE PRODUCT WATER

CAUSE	REMEDY
Ion Exchange Capacity of Q-Gard Pack and Quantum Cartridge exhausted (used up).	<ul style="list-style-type: none"> • Replace Q-Gard and Quantum at the same time.
Non Temperature Compensated Resistivity values shown and water temperature is > 25°C.	<ul style="list-style-type: none"> • Check the Temperature Compensated Resistivity Value. See Section 4-14.
Conductivity values ($\mu\text{S}/\text{cm}$) displayed.	<ul style="list-style-type: none"> • Nothing wrong. Change to a Resistivity Display to check values. See Section 4-13.
Something other than a Q-Gard Pack is installed by mistake.	<ul style="list-style-type: none"> • Check Catalogue Number of installed Pack. See Section 8-1.
Ion Exchange Resin was fouled by high levels of Colloidal Species in Feedwater. Occurs with Deionised Feedwater (i.e. Service Deionised Feedwater).	<ul style="list-style-type: none"> • Switch to a feedwater such as RO or Elix.
Problem with internal component.	<ul style="list-style-type: none"> • Contact Millipore

THE PROBLEM IS THERE IS NO POWER TO THE MILLI-Q SYSTEM

CAUSE	REMEDY
No voltage at Wall Electrical Outlet.	<ul style="list-style-type: none"> • Check Voltage at wall outlet.
Powercord not plugged into Milli-Q.	<ul style="list-style-type: none"> • Confirm that the Powercord is plugged in.
System not turned on.	<ul style="list-style-type: none"> • Confirm Power Switch is turned on.
Main Power Fuse blown.	<ul style="list-style-type: none"> • Replace Main Power Fuse. See Chapter 9 Appendix A.
Problem with internal component.	<ul style="list-style-type: none"> • Contact Millipore

THE PROBLEM IS THERE IS AN «ERROR NUMBER» ALARM DISPLAYED

CAUSE	REMEDY
<p>SYSTEM ERROR 1 displayed.</p>	<ul style="list-style-type: none"> • The voltage going to the Motor is > 49 VDC. • CONTACT MILLIPORE
<p>SYSTEM ERROR 2 displayed.</p>	<ul style="list-style-type: none"> • The measured temperature is 0 °C. • Is the feedwater very cold? • CONTACT MILLIPORE
<p>SYSTEM ERROR 3 displayed.</p>	<ul style="list-style-type: none"> • The measured temperature is > 45 °C. The system will still produce high quality water if the water is not really this warm (i.e. Error coming from a Thermistor problem). • Is the feedwater really this warm? • CONTACT MILLIPORE
<p>SYSTEM ERROR 4 displayed.</p>	<ul style="list-style-type: none"> • The measured Resistivity Value (@ 25°C) is between 3.5 MΩ.cm and 2.5 MΩ.cm. • See the Section above «The problem is Low Resistivity of the Product Water» for further information.
<p>SYSTEM ERROR 5 displayed.</p>	<ul style="list-style-type: none"> • The measured Resistivity Value (@ 25°C) is > 65.5 MΩ.cm. The displayed Resistivity may not show > 18.2 MΩ.cm. • Air in the Product Water tubing near the Resistivity Sensor can cause this. Make sure the Quantum Cartridge is Air Purged. See Section 4-7 for more information.
<p>SYSTEM ERROR 7 displayed.</p> <p>The POU Dispenser will not dispense water. You will not be able to dispense water.</p>	<ul style="list-style-type: none"> • Contact Millipore.
<p>SYSTEM ERROR 8 displayed.</p> <p>The POU Dispenser will not dispense water. You will not be able to dispense water.</p>	<ul style="list-style-type: none"> • Contact Millipore.

TROUBLESHOOTING

CAUSE	REMEDY
SYSTEM ERROR 10 displayed.	<ul style="list-style-type: none"> • There was a problem reading or writing data to the Data Storage Prom (E²Prom). • Placing the system into STANDBY Mode then back to PRE OPERATE Mode will erase this message for a few days. • The system will still produce high quality water. Continue to use the system. Contact Millipore to have this error fixed.
A10 ERROR 0 displayed.	A10 PCB E ² Prom defective. Turn off/on the Milli-Q and dispense water for > 6 minutes. If the message continues, then contact Millipore.
A10 ERROR 1 displayed.	A10 PCB A/D converter defective. Turn off/on the Milli-Q and dispense water for > 6 minutes. If the message continues, then contact Millipore.
A10 ERROR 2 displayed.	A10 Thermistor defective. Turn off/on the Milli-Q and dispense water for > 6 minutes. If the message continues, then contact Millipore.
A10 ERROR 3 displayed.	Problem occurred with temperature compensation. Turn off/on the Milli-Q and dispense water for > 6 minutes. If the message continues, then contact Millipore.
A10 ERROR 4 displayed.	The water entering the A10 is < 4°C. Contact Millipore.
A10 ERROR 5 displayed.	The water entering the A10 is > 41°C. Contact Millipore.
A10 ERROR 6 displayed.	The conductivity of the water entering the A10 is > 1.1 μS/cm. Contact Millipore.
A10 ERROR 7 displayed.	The temperature inside the A10 during its analysis Mode reached > 55°C. Contact Millipore.
A10 ERROR 9 displayed.	The TOC is very low or a problem occurred with the A10. Contact Millipore.

THE PROBLEM IS A MESSAGE IS DISPLAYED WITH A FLASHING SERVICE OR ALARM LED

LCD MESSAGE DISPLAYED	REMEDY
EXCH. CARTRIDGES displayed.	<ul style="list-style-type: none"> • The Q-Gard Pack and Quantum Cartridge have been installed for 180 Calendar Days or the Resistivity is < 16 MΩ.cm (the Resistivity Setpoint). • Replace the Q-Gard Pack and Quantum Cartridge. • Check the value of the Calendar Day timer and the Resistivity Setpoint – Contact Millipore to do this.
TOC > SETPOINT displayed.	<ul style="list-style-type: none"> • The displayed TOC is greater then the TOC Setpoint. Contact Millipore about changing the TOC Setpoint.
CARTRIDGE OUT displayed.	<ul style="list-style-type: none"> • Either the Q-Gard Pack or the Quantum Cartridge is not pushed in far enough or is absent.
NO FEED WATER displayed.	<ul style="list-style-type: none"> • Someone has installed a level sensor device to the Milli-Q. The level of Feedwater is too low according to the level sensor device.
REBOOT SYSTEM displayed.	<ul style="list-style-type: none"> • The A10 has been trying to process a TOC Analysis unsuccessfully for 15 minutes. • Turn off then on the electrical power to the Milli-Q. • Contact Millipore if this frequently occurs.
EXCHANGE A10 UV displayed.	<ul style="list-style-type: none"> • The small UV Lamp on the A10 TOC Monitoring Device has been installed for 365 Days. • You can continue to use the system to produce high quality water until the A10 UV Lamp is replaced.

OTHER TROUBLESHOOTING ITEMS

WHAT HAPPENED?	REMEDY
<p>Nothing shows up on the Printer.</p>	<ul style="list-style-type: none"> • The Printer will not print out Temperature and Resistivity values unless the system is in PRODUCT Mode. • Wrong Baud Setting on Milli-Q – Contact Millipore. • The Printer is not plugged into the Milli-Q system.
<p>System stops dispensing water after 30 minutes.</p>	<ul style="list-style-type: none"> • Perfectly normal. The Milli-Q will stop dispensing water from the POU after 30 continuous minutes. • Contact Millipore if you want to dispense water for more then 30 continuous minutes.
<p>Water drips out of the Millipak when you go back to PRE OPERATE Mode from PRODUCT Mode.</p>	<ul style="list-style-type: none"> • There is air in the Millipak. Vent the air out.
<p>You have used the automatic volume dispenser feature (see Section 5-5). The dispensed volume is not accurate.</p>	<ul style="list-style-type: none"> • Calibrate the Flowrate of Product Water. • Purge air from the Quantum Cartridge. • Vent the Millipak of trapped air.
<p>The displayed TOC is xxx ppb.</p>	<ul style="list-style-type: none"> • The measured TOC value is out of range (> 999 ppb) or the last measured TOC value is not stored in the system's memory.

Chapter 8 ORDERING INFORMATION

8-1 CATALOGUE NUMBERS FOR CONSUMABLES

Consumable Item	Catalogue Number	Comments
Q-Gard 1 Purification Pack	QGARD00R1	1/box, used for RO, Elix, Milli-RX, Milli-RO, distilled Feedwaters.
Q-Gard 2 Purification Pack	QGARD00D2	1/box, used for DI, Service DI Feedwaters.
Q-Gard B1 Purification Pack	QGARD00B1	1/box, used specifically for Boron Removal.
Q-Gard VX Purification Pack	QGARD00VX	1/box, used specifically for volatile organic species removal.
Quantum IX Cartridge	QTUM000IX	1/box, Millipak not included, used for applications needing trace levels of ions.
Quantum EX Cartridge	QTUM000EX	1/box, Millipak not included, used for applications needing trace levels of ions and trace levels of organic species.
Quantum VX Cartridge	QTUM000VX	1/box, Millipak not included, used for applications needing trace levels of volatile organic species and ions.
Quantum ICP Cartridge	QTUM00ICP	1/box, Millipak not included, used for sub ppt level elemental analysis.
Quantum IX Cartridge with Non-sterile Millipak Express 20	QTUMMPEIX	1 Quantum Cartridge + 1 Non-sterile Millipak Express 20 per box.
Quantum EX Cartridge with Non-sterile Millipak Express 20	QTUMMPEEX	1 Quantum Cartridge + 1 Non-sterile Millipak Express 20 per box.
Millipak 40 (Sterile)	MPGL04SK2	2/box, used for Life Science Applications.
Millipak 20 Express (Non-sterile)	MPGP02001	1/box, see Section 2-3 for more information.
BioPak	CDUFBIO01	1/box, used as a final filter on the POU Dispenser.
A10 UV Lamp	ZFA10UV01	1/box.
UV Lamp	ZMQUVLP01	1/box (gloves included).

ORDERING INFORMATION

8-2 CATALOGUE NUMBERS FOR ACCESSORIES

See Section 3-2 for information about the various accessories that can be used with a Milli-Q.

Accessory	Catalogue Number
Wall Mounting Bracket	SYSTFIX01
Pressure Regulator	ZFMQ000PR
Remote POU Dispenser (see below also)	ZMQSPOUR1
Installation Kit for Remote POU Dispenser	ZMQSPOU01
Footswitch	ZMQSFTS01
Remote Display	ZMQSRMDS1
Computer Cable	COMPCBL01
Printer Cable	PRNTCBL01
A10 TOC Monitor Upgrade Kit	ZMQUPGA11

8-3 CATALOGUE NUMBERS FOR ALL MILLI-QS

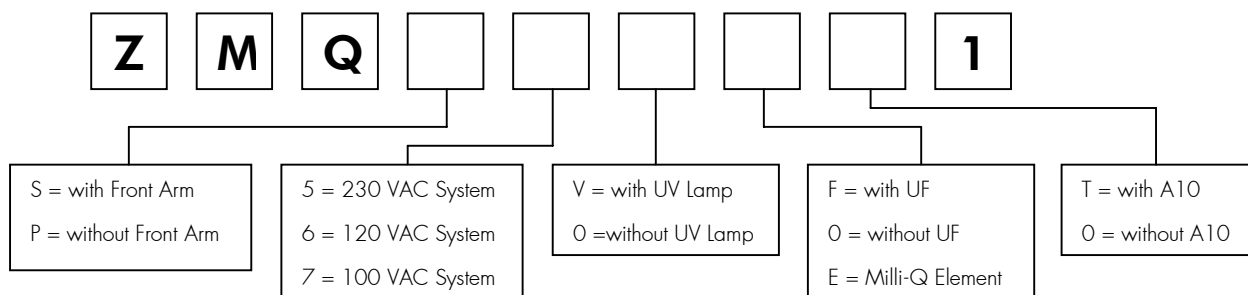

NOTE:

1. A Milli-Q System with a Front Arm comes with a POU Dispenser.
2. A Milli-Q System without a Front Arm does not come with a POU Dispenser. A Remote POU Dispenser would be needed.
3. Milli-Q Synthesis / Synthesis A10 / Gradient and Gradient A10 Systems have a UV Lamp inside.
4. Milli-Q Biocel / Biocel A10 / Synthesis / Synthesis A10 Systems have a UF inside.

Chapter 9 APPENDIXES

APPENDIX 1 HOW TO REPLACE THE MAIN POWER FUSE

Follow the steps below to replace the main Power Fuse.

Place the Milli-Q into STANDBY Mode if it is in PRE OPERATE or PRODUCT Mode. See Section 5-1 for more information.

1. Turn off the Milli-Q Power Switch. It is located on the back of the Milli-Q cabinet just above the location where the Powercord is plugged into the Milli-Q.
2. Unplug the Powercord from the Milli-Q System.
3. Obtain the correct replacement fuse. There is a spare fuse located in the fuse holder. See Step 4.

It is very important to use the correctly sized replacement fuse. Failure to use the correct replacement fuse could result in system damage or an electrical fire.

System Voltage	Main Power Fuse Size
120 VAC \pm 10%	2 Amp. Time Lag 250 VAC 5 mm x 20 mm
230 VAC \pm 10%	1 Amp. Time Lag 250 VAC 5 mm x 20 mm

4. Use a small flathead screwdriver to open the Fuse Holder. This is located immediately above the point where the Powercord plugs in.
5. Remove the entire fuse holder. Replace the blown fuse (you can check the fuse for electrical continuity with an Ohmmeter).
6. Place the Fuse Holder back into the Milli-Q System. Put the Powercord back in. Turn on the Power Switch.
7. The LCD will show the type of system, the system serial number and software version for a few seconds. Wait about 10 seconds for this to go away.
8. Place the system back to PRE OPERATE Mode or whatever mode it was previously in.



ATTENTION

CONTACT MILLIPORE IF THE MAIN POWER FUSE BLOWS AGAIN.

REPLACEMENT OF MAIN POWER FUSE

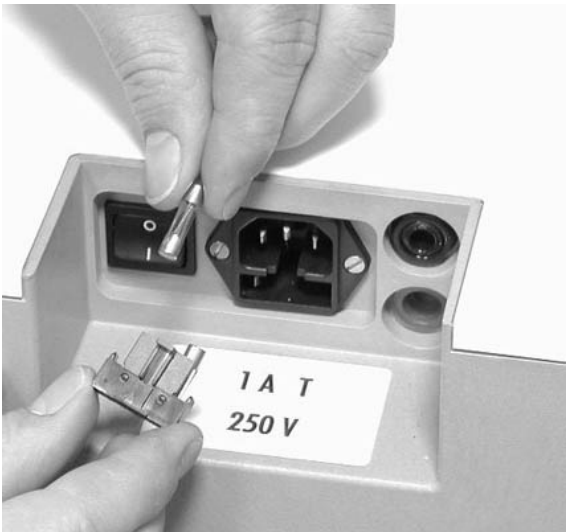
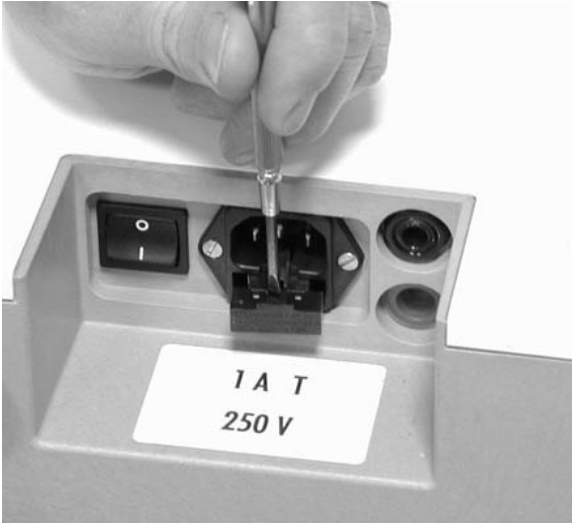

APPENDIX 2 HOW TO TRANSFER INFORMATION TO A PRINTER

It is possible to transfer ('download') information to a printer from the Milli-Q.

REQUIREMENTS NEEDED

A cable is needed to connect between the Milli-Q and a printer. The Millipore Catalogue number for this cable is PRNTCBL01. This Printer Cable is an accessory for the Milli-Q and needs to be ordered separately.

A Printer with a Serial Port is necessary. It is not possible to use Parallel Transmission from the Milli-Q. Any 20/24 Column Serial Port Printer can be used.

An example of a Serial Port Printer that has been used with Milli-Q systems is the Epson LX-300.

WHAT TO DO

- ❑ Make sure the Printer Cable is installed between the Milli-Q and the Printer. The installation instructions for this cable are not provided in this manual. The installation instructions come with the Printer Cable.
- ❑ Make sure the Printer is 'on-line' and has paper and so forth.
- ❑ Make sure the Milli-Q is in PRODUCT Mode. It is not possible to print while the Milli-Q is in PRE OPERATE or STANDBY Mode.
- ❑ Press the MENU Keypad Button for about 2 seconds. The LCD will change as shown here.

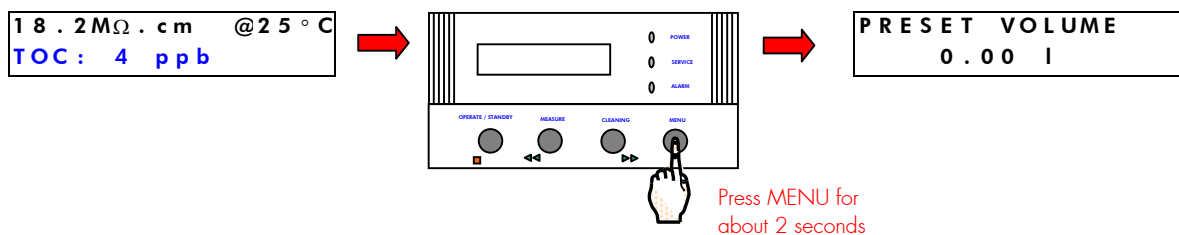

- ❑ Press the MENU Keypad Button one more time. The LCD will change as shown here.

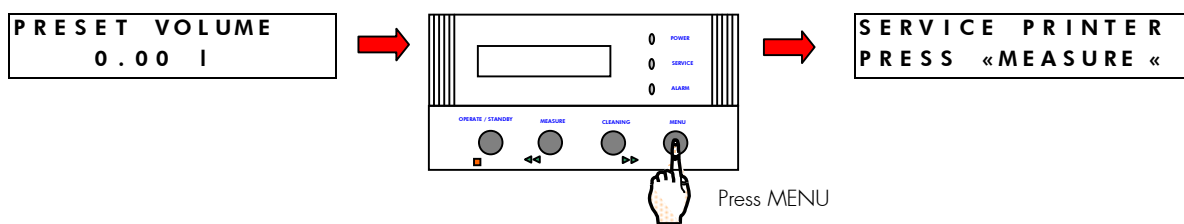

- ❑ Press the MEASURE Keypad Button. The Printer will start to print. The Milli-Q will return to PRODUCT Mode automatically.

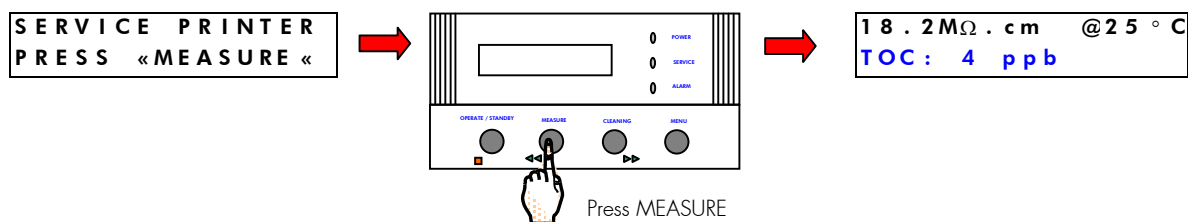

WHAT DOES THE PRINTOUT LOOK LIKE?

An example Printout is shown here.

```
*****  
*      MILLIPORE      *  
*****  
  
SYSTEM: GRADIENT A10  
SERIAL N°: F1JW8765A  
PROGR.VERSION: V3.01  
  
*  QUALITY REPORT  *  
  
DATE: JUL-13/01  
  
USER NAME:  
  
TEMPERATURE: 17.8°C  
  
@25°C CORRECTION ON  
PRODUCT:      18.2 MΩ.cm  
  
TOC:          3ppb
```

APPENDIX 3 HOW TO TRANSFER INFORMATION TO A COMPUTER

It is possible to transfer ('download') information to a computer from the Milli-Q.

REQUIREMENTS NEEDED

A cable is needed to connect between the Milli-Q and a computer. The Millipore Catalogue number for this cable is COMPCBL01. This Computer Cable is an accessory for the Milli-Q and needs to be ordered separately.

The computer end of this cable has a 9 pin connection. It installs into either the COM1 or COM2 Port of your computer.

HOW TO DO IT

- ❑ Connect the Computer Cable (COMPCBL01) between the Water System and the Computer. The installation instructions are not in this manual. The installation instructions come with the Computer Cable.
- ❑ Using Windows® 95 or 98, click on START, then PROGRAMS, then ACCESSORIES, then HYPERTERMINAL.

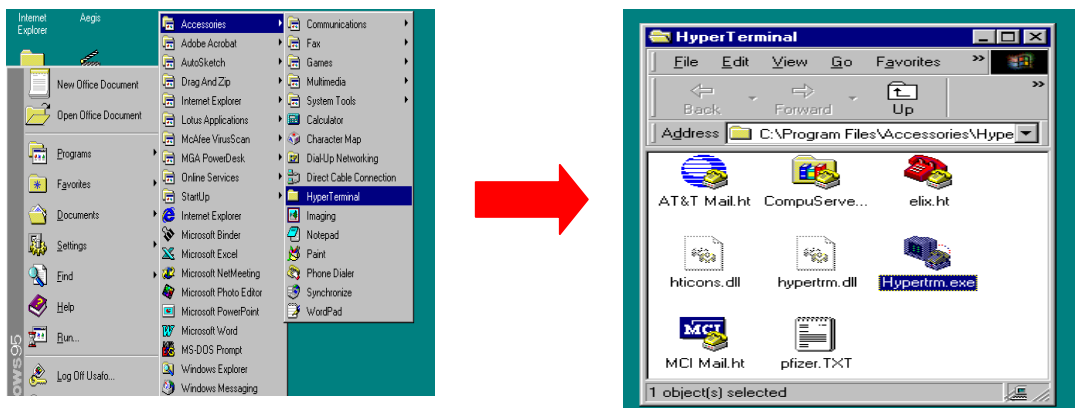

- ❑ Double Click on the HYPERTRM.EXE icon.
- ❑ Enter a name (example: Elix) and then choose an icon. You can use this later for future downloads.

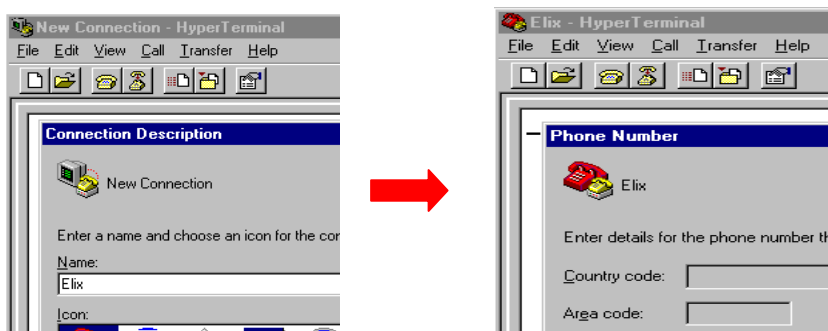

- ❑ Choose 'Direct to COM 1 (or COM 2)', then click on OK.

- For the COM properties, change the settings to be:

Bits Per Second: 9600
Data bits: 8
Parity: none
Stop bits: 1
Flow Control: none

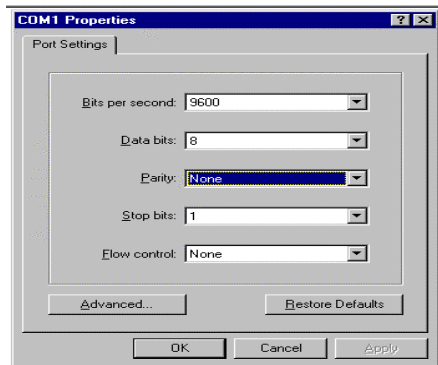

- **Click OK**
- Open the TRANSFER menu and click on CAPTURE TEXT. Choose a file name for the data to be downloaded. By default, the data will be saved in the directory:

C:\ProgramFiles\Accessories\Hyperterminal\.txt

- Now click on START

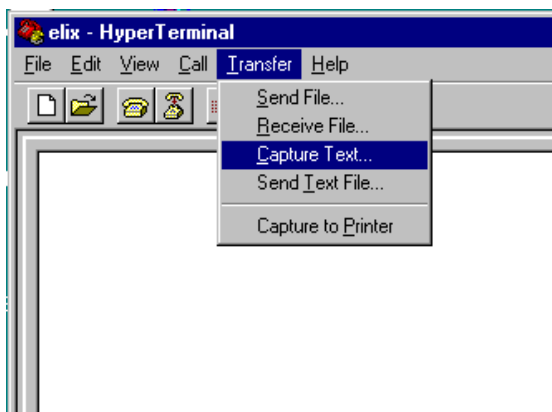

Elixdata.txt is an example file name shown below

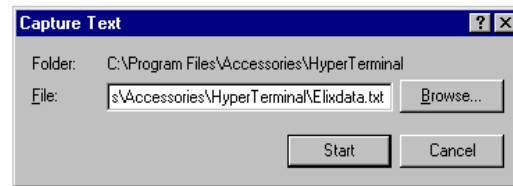

- Make sure the Milli-Q is in PRODUCT Mode. It is not possible to download to a computer while the Milli-Q is in PRE OPERATE or STANDBY Mode.
- Press the MENU Keypad Button for about 2 seconds. The LCD will change as shown here.

18 . 2 MΩ . cm @ 25 ° C
 TOC : 4 ppb

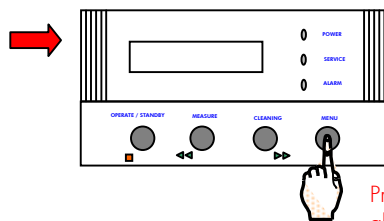

PRESET VOLUME
 0 . 0 0 l

Press MENU for about 2 seconds

- Press the MENU Keypad Button one more time. The LCD will change as shown here.

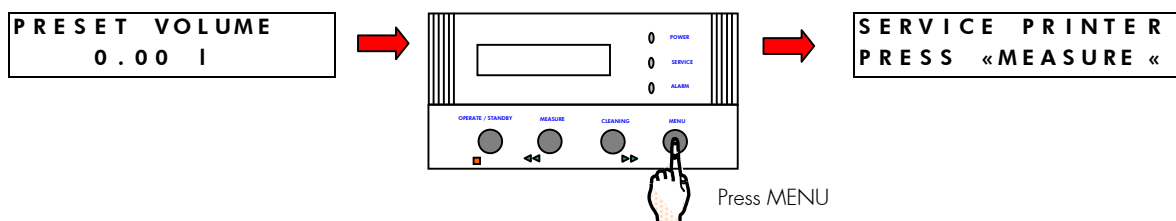

- Press the MEASURE Keypad Button. Information will be sent to the Computer. The Milli-Q will return to PRODUCT Mode automatically.

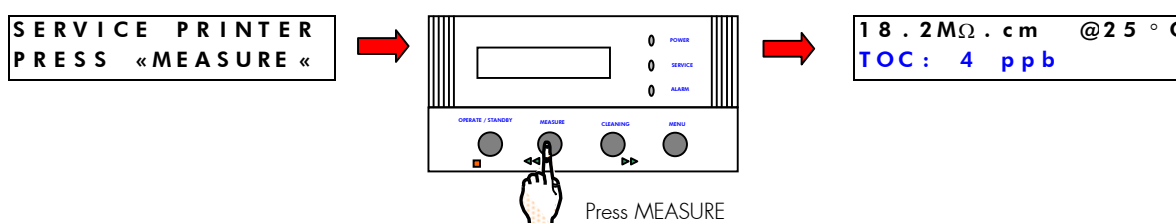

- When the data transfer is complete, open the TRANSFER menu and then click on CAPTURE TEXT STOP.

To transfer this data into an EXCEL® file:

1. Open Microsoft EXCEL. Open the file you downloaded (it will have a .txt file extension).
2. Choose DELIMITED for the FILE TYPE of your data. Press NEXT. TAB is the Delimiter.
3. Press NEXT and then FINISH.
4. Save the new file as a Microsoft Excel Workbook if you want to graph the data or do any calculations with the data.

APPENDIX 4 HOW TO USE A REMOTE DISPLAY

The Remote Display is an accessory that allows you to have the LCD and Keypad and LEDs located up to 2.4 meters away from the Milli-Q System.

The Millipore Catalogue Number for the Remote Display is ZMQSRMDS1.

The Remote Display Installation Instructions are not included with this Owner's Manual. These Installation Instructions are included with the Remote Display. Please contact Millipore if you would like a copy of these instructions ahead of time.

All of the instructions given in this manual will work with the Remote Display. For example, suppose you wanted to use the Volumetric Dispenser Function of the Milli-Q (See Section 5-5). The use of the Keypad is exactly the same when using the Remote Display.

APPENDIX 5 HOW TO USE A REMOTE POU DISPENSER

The Remote POU Dispenser is an accessory that allows you to dispense Milli-Q Product Water up to 2.5 meters away from the Milli-Q system. The Remote POU Dispenser uses the same POU Device found on the front of the Milli-Q. The Remote POU Dispenser Arm is fixed to a Base. The Base can be wall mounted or the Base can be fitted with a metal weight for placement on a table or countertop.

The Millipore Catalogue Number for a Remote POU Dispenser is ZMQSP0UR1.

It is also necessary to have an Installation Kit for the Remote POU Dispenser. This kit allows an interface between the Remote POU Dispenser and the Milli-Q. **The Millipore Catalogue Number for the Remote POU Dispenser Installation Kit is ZMQSP0U01.**

The installation instructions for the Remote POU Dispenser are not included with this manual. These instructions are included with the Remote POU Dispenser. Please contact Millipore if you would like a copy of these instructions ahead of time.

The use of the Remote POU Dispenser is exactly the same as one mounted on the Front of the Milli-Q Cabinet.

It is suggested to recalibrate the flowrate from the Milli-Q if you are using the Remote POU Dispenser more often than the Front POU Dispenser. The flowrate from the Remote POU Dispenser may be slightly lower than the Front POU Dispenser.

APPENDIX 6 COMP MODE 1 AND COMP MODE 2

Section 4-14 in this manual explains how to display Non Temperature Compensated Resistivity or Non Temperature Compensated Conductivity Displays. When you are using the Milli-Q Software to make this change, you may notice the terms COMP MODE 1, COMP MODE 2 and OFF.

What do these mean?

OFF means that the Temperature Compensation is off. The displayed Resistivity or Conductivity will not be temperature compensated. The temperature of the water will be shown at the same time as the non temperature compensated Resistivity or Conductivity value.

COMP MODE 1 is the normal setting. This setting will display Resistivity or Conductivity values that are temperature compensated to 25°C. The values are normalised. The Software of the Milli-Q eliminates small fluctuations of temperature compensated Resistivity or Conductivity due to the fact that these two parameters are not measured at the same time.

COMP MODE 2 is a setting that gives the actual temperature compensated Resistivity or Conductivity values. In some operating conditions the feed water can be warmer or cooler than the water temperature inside the Milli-Q. This can cause small fluctuations of the resistivity and Conductivity values. Resistivity values could fluctuate between 18.0 MΩ.cm and 18.4 MΩ.cm @ 25°C while the actual resistivity value is 18.2 MΩ.cm @ 25°C. The COMP 2 setting should be used in applications that require the detection of trace ionic levels or when performing the verification of the Milli-Q Resistivity Meter Operation with an independent calibrated Resistivity Meter.